

High Pressure Precise Metering Valves

15M Series, 15,000 psi (1034 bar)

30M Series, 30,000 psi (2068 bar)

60M Series, 60,000 psi (4137 bar)



FITOK Group

FITOK GmbH (Headquarter)

Sprendlinger Landstr. 115, 63069 Offenbach, Germany
Tel.: +49 69 8900 4498
Fax: +49 69 8900 4495

FITOK INC.

13000 Murphy Road, Suite 116, Stafford, TX 77477, USA
Tel.: +1 281 888 0077
Fax: +1 281 888 0033

FITOK INCORPORATED

Yingtailong Industrial Park, Shenzhen, 518109, China
Tel.: +86 755 2803 2500
Fax: +86 755 2803 2619

info@fitokgroup.com
www.fitokgroup.com

FH09040813

FITOK
Valves and Fittings

www.fitokgroup.com

Introduction

FITOK Precise Metering Valves provide the highest degree of precision metering for moderate pressure applications. Precise Metering Valves are designed to provide accurate and stable control of flow rates in analytical instrumentation. This valve offers the ultimate in precision small flow control.

Features

- ⦿ The design of Barrel and Thimble micrometer permits repeatable settings. Each division of barrel equal to 0.025". Thimble is divided into 25 divisions, each division of thimble equal to 0.001" stem travel. One revolution equal to valve stem 0.025" travel.
- ⦿ Precise Metering Valves are not intended for use as shut-off valves.
- ⦿ The minimum flow rate is set at "0" position before shipping. The valve will be damaged when the valve is operated below "0" position. When shutoff is required, a correlated shutoff valve from 15B, 20B, 15N, 20N, 30N and 60N series valve should be installed with the Precise Metering Valves.
- ⦿ The location of packing is under the thread of valve stem.
- ⦿ Reliable locking device of packing gland design.

Technical Data

Series	Tube OD in.	Connection Type	Orifice in. (mm)	Cv	Pressure @ Room Temperature psig (bar)
15M	1/4	FH4	0.062 (1.57)	0.04	15,000 (1034)
30M	1/4	6FH4	0.062 (1.57)	0.04	30,000 (2068)
60M	1/4	6FH4	0.062 (1.57)	0.04	60,000 (4137)
60M	3/8	6FH6	0.062 (1.57)	0.04	60,000 (4137)

Packing Options:

The standard packing material for 60M series metering valve is Nylon, the other series are PTFE. RPTFE glass, Graphite and Extend stuffing box valve with graphite also available. Normal Precise Metering Valve with Nylon packing can be operated to 230°F (110°C). Normal Precise Metering Valve with PTFE packing can be operated to 450°F (232°C). Normal Precise Metering Valve with RPTFE glass packing can be operated to 600°F (316°C). Normal Precise Metering Valve with Graphite packing can be operated to 800°F (427°C). Extend stuffing box valve with Graphite can be operated to 1200°F (649°C).

Flow Data at 100°F (38°C)

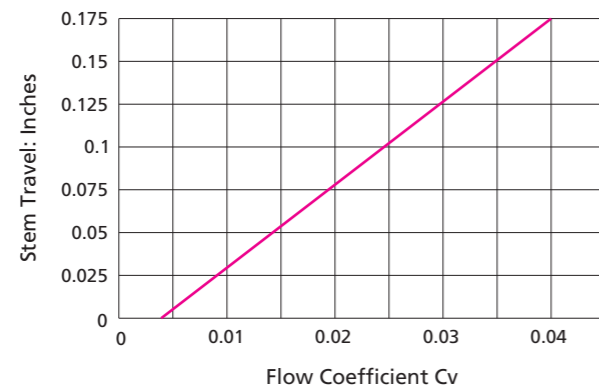

Pressure & Temperature

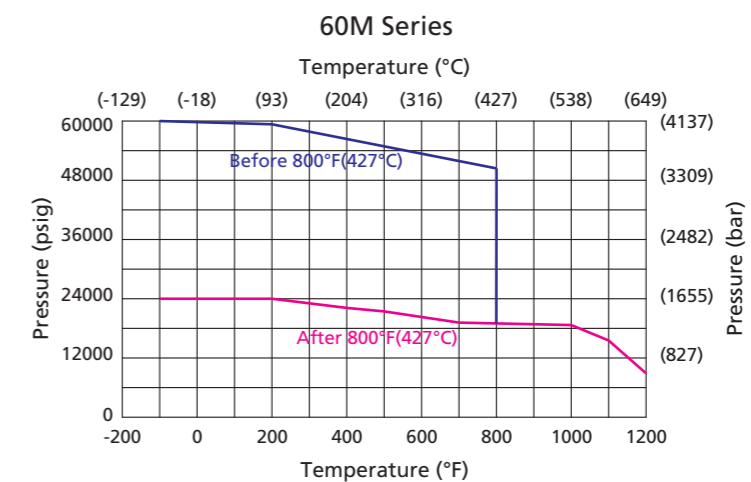
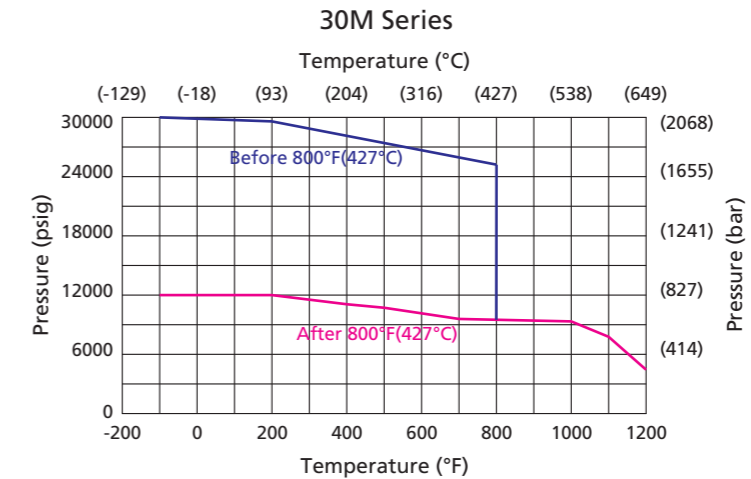
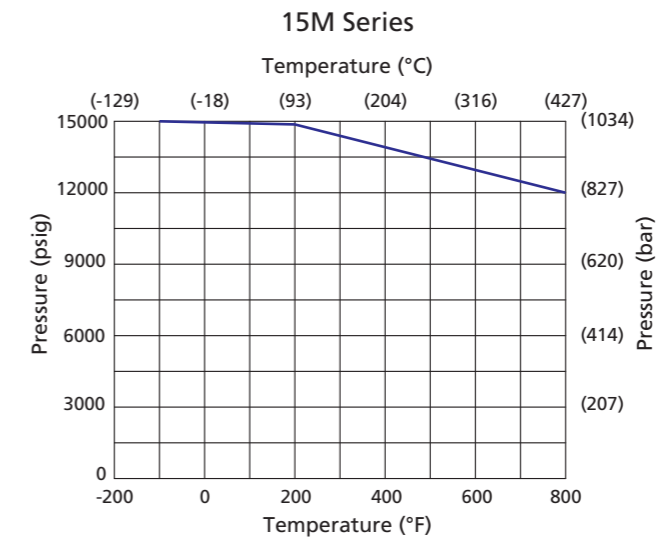

About 30 Series and 60 Series:
When exceeding 800°F (427°C), use the pink curve as its cold-worked rating for future operating of the components.

Standard Materials of Construction

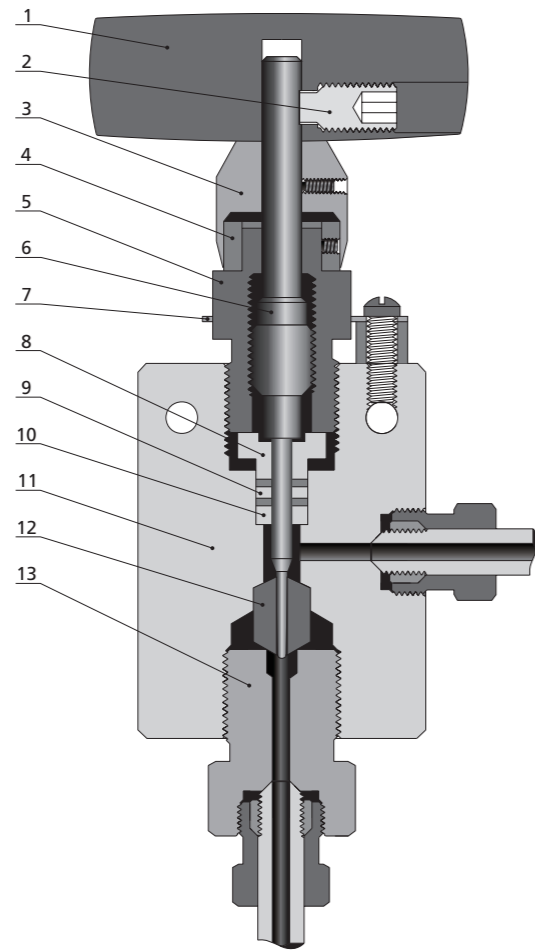

Item	Component	Material Grade/ASTM Specification
1	Handle	Stainless steel handle
2	Handle Screw	Stainless steel
3	Thimble	304 SS/A276
4	Barrel	304 SS/A276
5	Packing Bolt	C63000/B150
6	Stem	17-4PH/A564
7	Locking Plate	304 SS/A240
8	Packing Gland	C63000/B150
9	Packing	PTFE/RPTFE/Graphite/Nylon/ Extend stuffing box valve with Graphite
10	Packing Washer	17-4PH/A564
11	Body	316 SS/A479
12	Seat	17-4PH/A564
13	Seat Gland	316 SS/A479
	Lubricant	Molybdenum disulfide

Dimensions

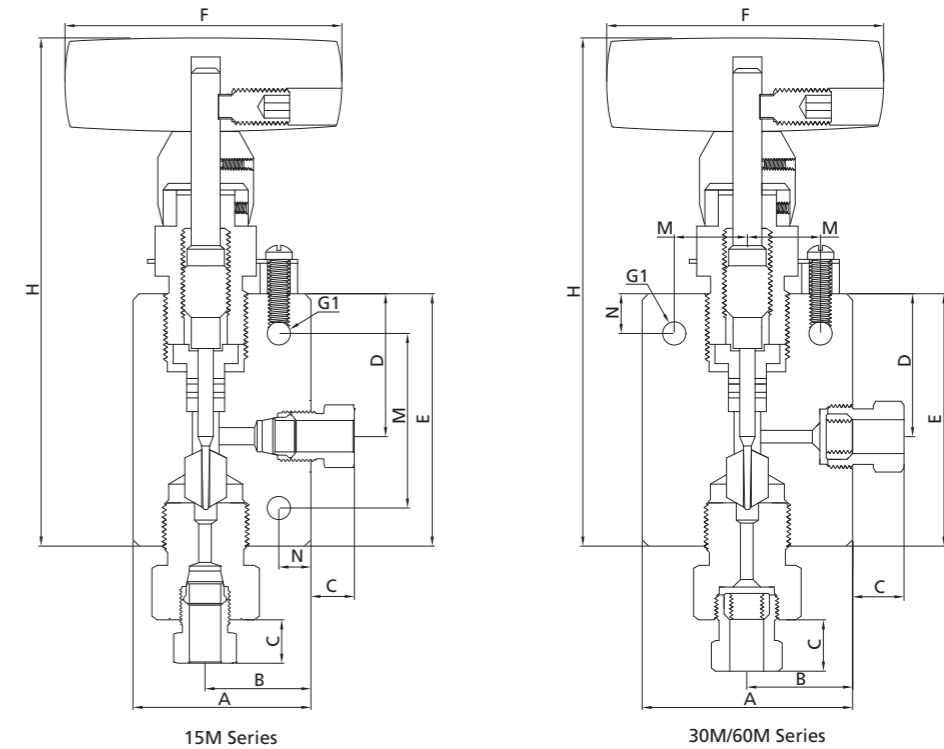

Dimensions														
Ordering Number	Connection Type	Orifice in. (mm)	A	B	C	D	E	F	G	G1	H	M	N	Thickness
			in.(mm)											
15MSS-FH4	FH4	0.062 (1.57)	1.63 (41.3)	1.00 (25.4)	0.44 (11.2)	0.94 (23.8)	1.56 (39.6)	3.00 (76.2)	0.87 (22.1)	0.16 (4.1)	5.06 (128.5)	1.00 (25.4)	0.38 (9.7)	0.75 (19.1)
30MSS-FH4	6FH4	0.062 (1.57)	2.00 (50.8)	1.00 (25.4)	0.50 (12.7)	1.12 (28.5)	2.00 (50.8)	3.00 (76.2)	0.97 (24.6)	0.22 (5.6)	5.06 (128.5)	0.69 (17.3)	0.50 (12.7)	1.00 (25.4)
60MSS-FH4	6FH4	0.062 (1.57)	2.00 (50.8)	1.00 (25.4)	0.50 (12.7)	1.31 (33.3)	2.63 (66.8)	3.00 (76.2)	0.97 (24.6)	0.22 (5.6)	6.00 (152.4)	0.69 (17.3)	0.38 (9.7)	1.00 (25.4)
60MSS-FH6	6FH6	0.062 (1.57)	2.00 (50.8)	1.00 (25.4)	0.53 (13.5)	1.31 (33.3)	2.63 (66.8)	3.00 (76.2)	0.97 (24.6)	0.22 (5.6)	6.06 (153.9)	0.69 (17.3)	0.38 (9.7)	1.00 (25.4)

- Note:**
- G is the drill dimension of packing bolt mounting hole.
 - G1 is the dimension of bracket mounting hole.
 - Panel mounting drill size: 0.25" all valves.
 - H is the dimension when stem is in closed position.
 - All dimensions are for reference only and are subject to change. For dimensions are not shown above, please contact the authorized representative or FITOK Group.

Part Number Description

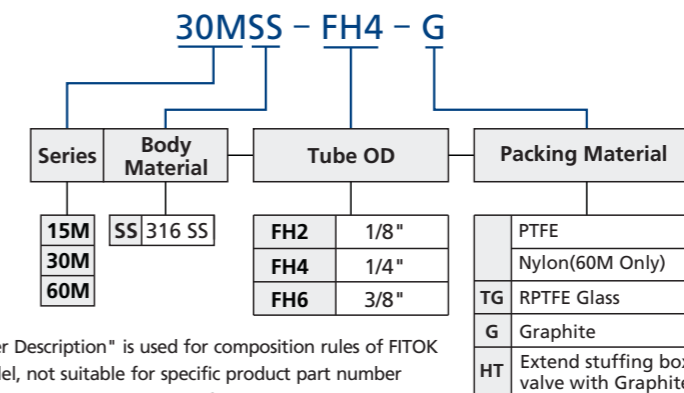

Note: "Part Number Description" is used for composition rules of FITOK product model, not suitable for specific product part number selection, not random combinations. If in doubt, please contact FITOK company or authorized agents.