

Magnescale

Digital Gauge General Catalog

SPEED X PRECISION



Magnescale

SPEED X PRECISION

Digital Gauge

Magnescale Co., Ltd.

Shinagawa Intercity Tower A-18F, 2-15-1, Konan, Minato-ku, Tokyo 108-6018, JAPAN

Headquarters : 45 Suzukawa, Isehara-shi, Kanagawa 259-1146, JAPAN

Tokyo Office : Shinagawa Intercity Tower A-18F, 2-15-1, Konan, Minato-ku, Tokyo 108-6018, JAPAN

Nagoya Office : 2-35-16, Meieki, Nakamura-ku, Nagoya Aichi, 450-0002, JAPAN

Osaka Office : 2-14-6, Nishi-Nakajima, Yodogawa-ku, Osaka 532-0011, JAPAN

International Sales Department : 45 Suzukawa, Isehara-shi, Kanagawa 259-1146, JAPAN

Magnescale Americas Inc. : 5740 Warland Drive, Cypress, CA 90630, USA

Magnescale Europe GmbH : Antoniusstrasse 14, 73249 Wernau, Germany

TEL.+81(0)463-92-1011 FAX.+81(0)463-92-1012

TEL.+81(0)3-5460-3574 FAX.+81(0)3-5460-9614

TEL.+81(0)52-587-1823 FAX.+81(0)52-587-1848

TEL.+81(0)6-6305-3101 FAX.+81(0)6-6304-6586

TEL.+81(0)463-92-7971 FAX.+81(0)463-92-7978

TEL.+1(562)594-5060 FAX.+1(562)594-5061

TEL.+49(0) 7153 934 291 FAX.+49(0) 7153 934 299

<http://www.mgscale.com>

The contents of this literature are as of Jul. 2011

This catalog is printed with soy ink.

MGS-DG-1107-EN-C

Magnescale Co., Ltd.

Safety

No compromise for high-accuracy products



The total quality control system that operates throughout the entire design and production process ensures products with enhanced safety, high quality, and high reliability that match our customers' requirements. The company is certified for length calibration in compliance with the traceability system required by the "Weights and Measures Act," and has been granted ISO 9001 certification, which is the international standard for quality assurance.



Isehara plant is registered to ISO 9001 (Quality)

Our products comply with CE Marking requirements, have acquired UL certifications and meet other regulations, ensuring safe use the world over.

We have met:

•EMC Directives(CE)

EMI: EN 55011 Group 1 Class A / 91

EMS: EN 61000-6-2

•FCC regulation

FCC Part 15 Subpart B Class A

for Products with built-in AC power supply:

•UL 61010-1

for Products with Laser:

•DHHS Class 1 (21CFR1040.10)

* When using our devices with machines to which the European Machinery Directive applies, please make sure that the devices when installed on the machines fulfill the applicable requirements of the Directive.
 * Standards or regulations to be complied with may vary by product.

Traceability

Traceability Flow Chart (Length)

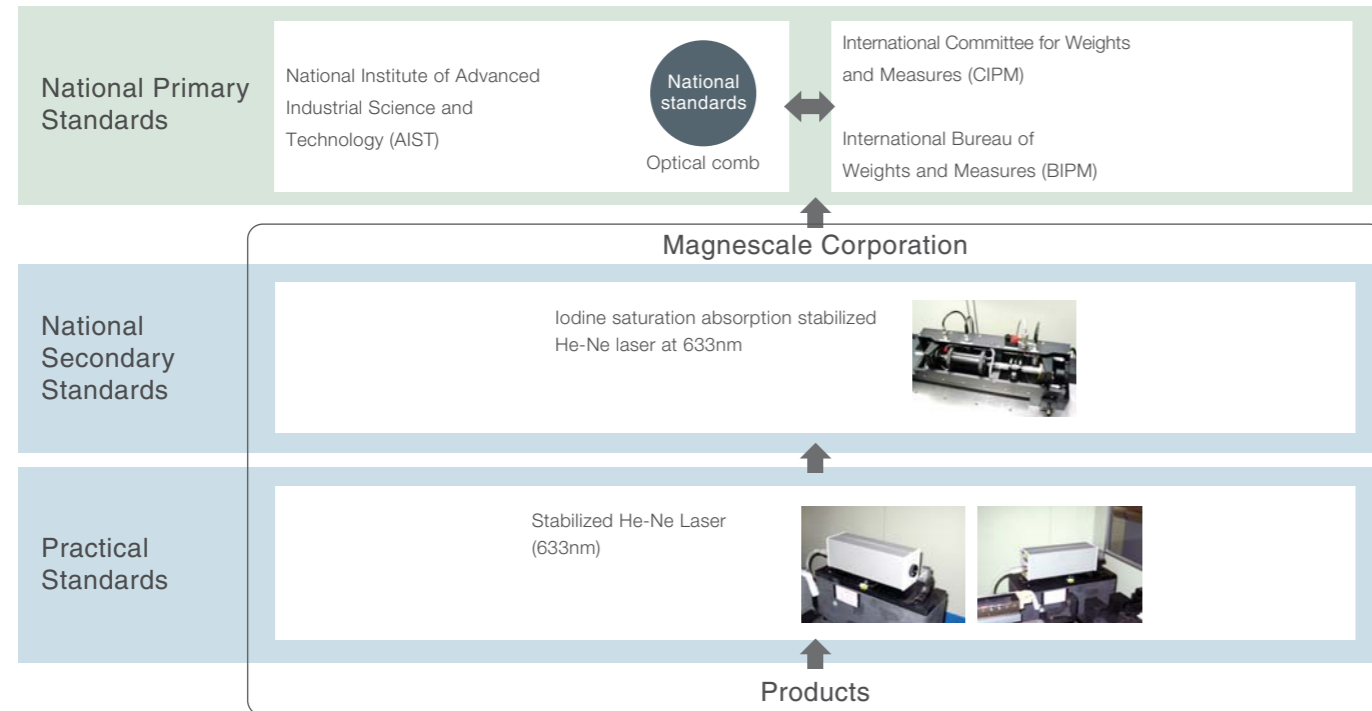

Magnescale Corporation

DIGITAL GAUGE

Contents

Safety	2	DT512 series	30
Traceability	2	DT12 / 32 series	31
Contents	3	MT12 / 13 / 14	33
Applications	4	DL-B series	34
Lineup	6	U series	36
System	8	Interface unit	39
Gauge	9	MG40 series	40
DK802 A/Bseries	10	MG10/20/30 series	42
DK805 A/Bseries	11	Counter unit	45
DK812 A/Bseries	12	LT30 series	46
DK10/25 series	13	LT20A series	47
DK50/100 series	14	LT11A series	48
DK155/205	15	LT10A series	49
DK110	16	LY71	50
DE-BR series	20	LY72	51
DG805/DG810 series	22	Technical information	52
DG10/25 series	23	Accessories	53
DG50 / 100 / 155 / 205 series	24	Connection Cables	54
DG110 series	26	Compatible	55

Applications

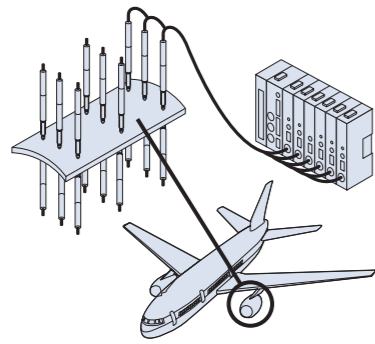

Multipoint measurement of turbine blades
Measures the blade shape of aircraft turbine blades.

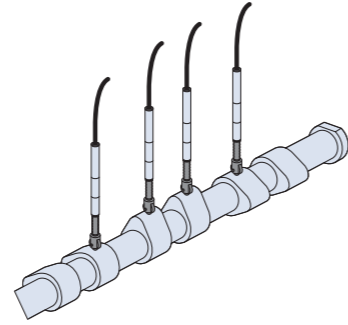

Camshaft displacement measurement
Measuring the height of camshaft lobes and journals.

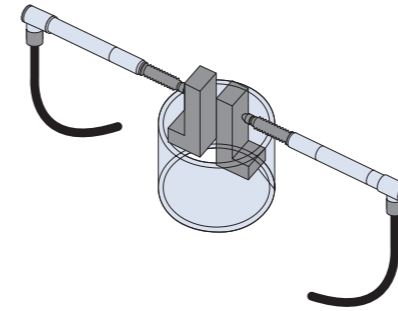

Measurement of inner diameter
Measuring the inner diameter of work.

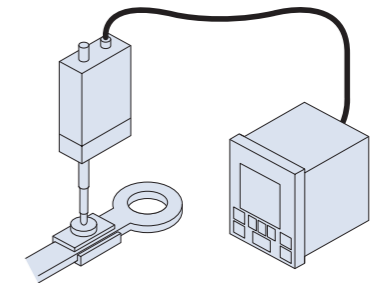

Measurement of crimp height
Measures the calking height of crimp terminal.

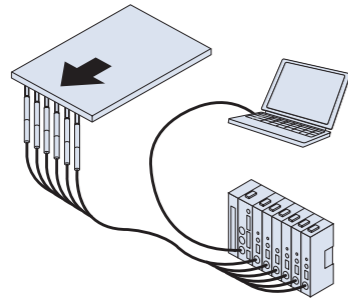

Multipoint measurement of liquid crystal panels
Measurement can be conducted easily in a small space by using a slim-shape measuring unit with fixture.

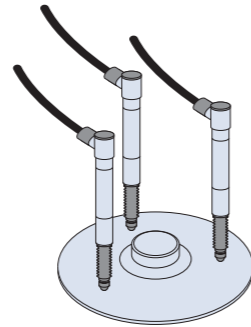

Measurement of hard disc flatness
Measuring the flatness of mass-produced discs.

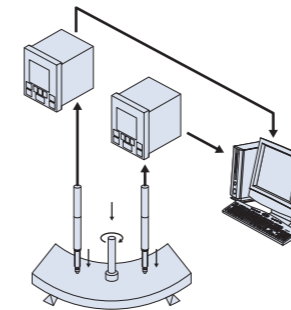

Measurement of material strength
Applicable for strength tests of various materials such as metal, resin materials and wood. Measuring unit is resistant to vibration.

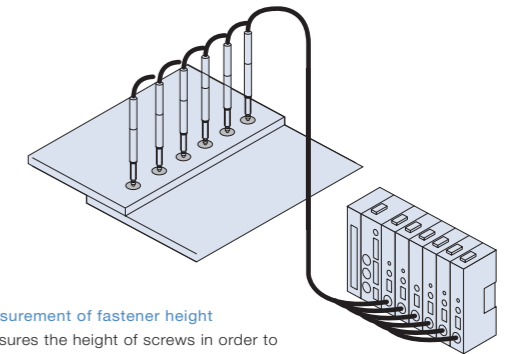

Measurement of fastener height
Measures the height of screws in order to control the amount of torque.

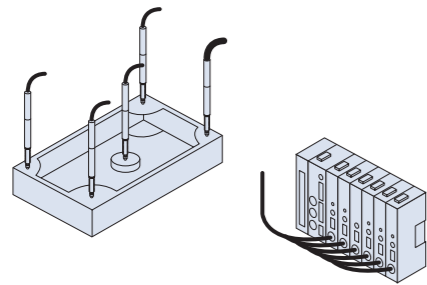

Measurement of the height of chassis height
Measurement can be conducted easily in a small space by using a slim-shape measuring unit. Measuring multiple points or a chassis.

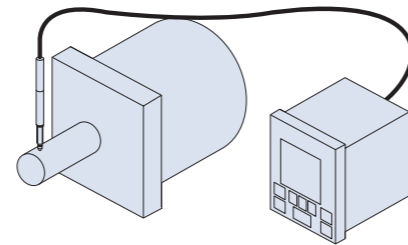

Measurement of motor shaft deviation
Measurement of a high speed spinning object is possible by utilizing a vibration-resistant gauge.

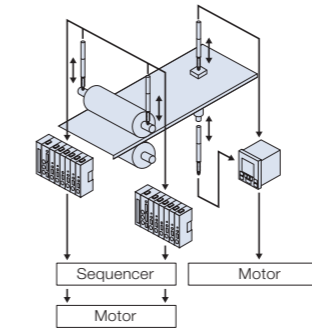

Positioning control
Measuring the thickness and flatness of objects moving at high-speed, such as metal plates, resin boards and film, as well as to control the position of feeding rollers.

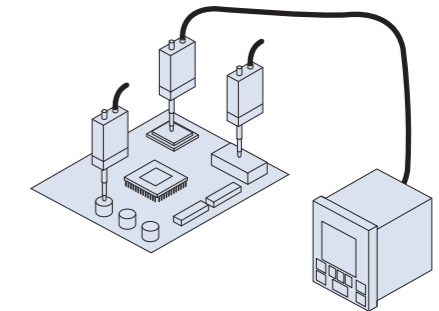

Measurement of the height of high-density mounting wiring boards
High-density measurement is possible with a slim-shaped measuring unit.

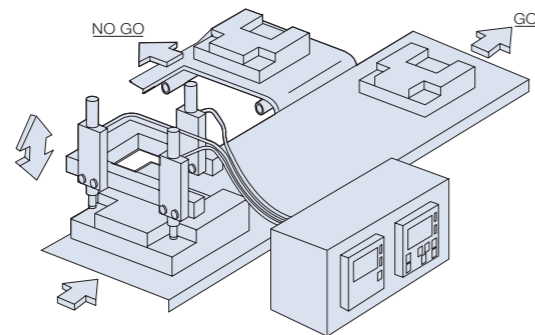

Automatic measurement and screening
Measurement/QA decisions can be performed on the production line.

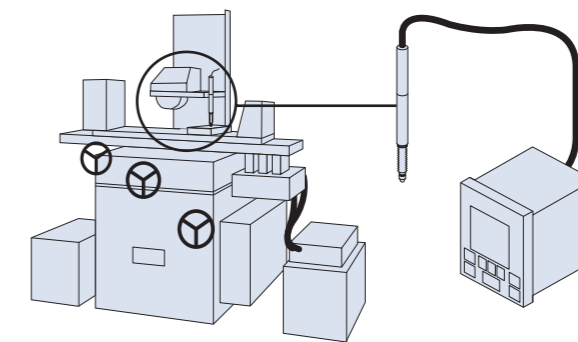

Combination with machine tools
Measuring the position of the grinding stone of surface grinding machines.

Lineup

Resolution (μm)	0.1		0.5		1	5	10	
	DK	DE	DK	DG	DT	DT	DL	
Measuring range (mm)								
Digital Gauge	2	DK802AR, DK802BR (Straight) DK802ALR, DK802BLR (Right angle)		DK802AR5, DK802BR5 (Straight) DK802ALR5, DK802BLR5 (Right angle)				
	5.2	DK805AR, DK805BR (Straight) DK805ALR, DK805BLR (Right angle) DK805AFR, DK805BFR (Straight • Flange) DK805AFLR, DK805BFLR (Right angle • Flange)		DK805AR5, DK805BR5 (Straight) DK805ALR5, DK805BLR5 (Right angle) DK805AFR5, DK805BFR5 (Straight • Flange) DK805AFLR5, DK805BFLR5 (Right angle • Flange)	DG805BL (Right angle • Low measuring force) DG805FL (Right angle • Flange • Low measuring force)			
	10			DK10PR5 (Straight • Protect sealing) DK10NR5 (Straight) DK10PLR5 (Right angle • Protect sealing)	DG810B (Straight) DG810BL (Right angle) DG810F (Straight • Flange) DG810FL (Right angle • Flange) DG10B (Straight)			DL310B (Straight • Protect sealing)
	12	DK812AR, DK812BR (Straight) DK812ALR, DK812BLR (Right angle)	DE12BR (Straight)	DK812AR5, DK812BR5 (Straight) DK812ALR5, DK812BLR5 (Right angle)		DT512N (BOX type) DT512P (BOX type • Protect sealing)	DT12N (Straight) DT12P (Straight • Protect sealing)	
	25			DK25PR5 (Straight • Protect sealing) DK25NR5 (Straight) DK25PLR5 (Right angle • Protect sealing) DK25NLR5 (Right angle)	DG25BN (Straight) DG25BP (Straight • Protect sealing) DG25BL (Right angle) DG25BS (Right angle) DG25B (Straight • Protect sealing)			
	30 32		DE30BR (Straight)				DT32N (Box type) DT32NV (Box type • Pneumatic push) DT32P (Box type • Protect sealing) DT32PV (Box type • Protect sealing • Pneumatic push)	DL330B (Straight)
	50 60			DK50PR5 (Straight • Protect sealing) DK50NR5 (Straight)	DG50BN (Straight) DG25BP (Straight • Protect sealing)			
	100 110			DK100PR5 (Straight • Protect sealing) DK100NR5 (Straight) DK110NLR5 (Right angle • Protect sealing)	DG100B (Straight) DG110B (Right angle)			
	155			DK155PR5 (Straight • Protect sealing)	DG155B (Straight)			
	205			DK205PR5 (Straight • Protect sealing)	DG205B (Straight)			
Counter	DIN size	LT30	LT30 + SZ70-2 (Adapter)	LT30	LT20A	LT11A	LT10A	LT20A
	Full type	•LY71 •LY72 (Connection cable CE29)	•LY71, LY72 (+SZ70-1 (Adapter))	•LY71 •LY72 (Connection cable CE29)	•LY71, LY72 (+DZ51 +SZ70-1)	•LY71, LY72 (+MT13 +CE29)	•LY71, LY72 (+MT13 +CE29)	•LY71 •LY72 (+DZ51 +SZ70-1)
Interface	MG40 series MG30 MG20-DK MG10	MG30 MG20-DK MG10 (+ SZ70-2 (Adapter))	MG40 series MG30 MG20-DK MG10	MG30 MG20-DG MG10	MG30 MG20-DT MG10	MG30 MG20-DT MG10	MG30 MG20-DG MG10	

System

Interface unit

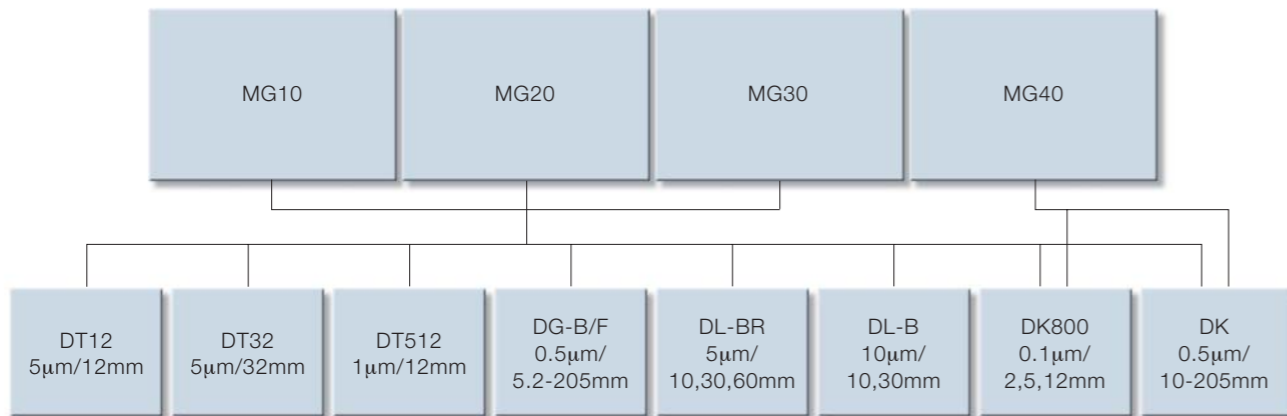

Counter

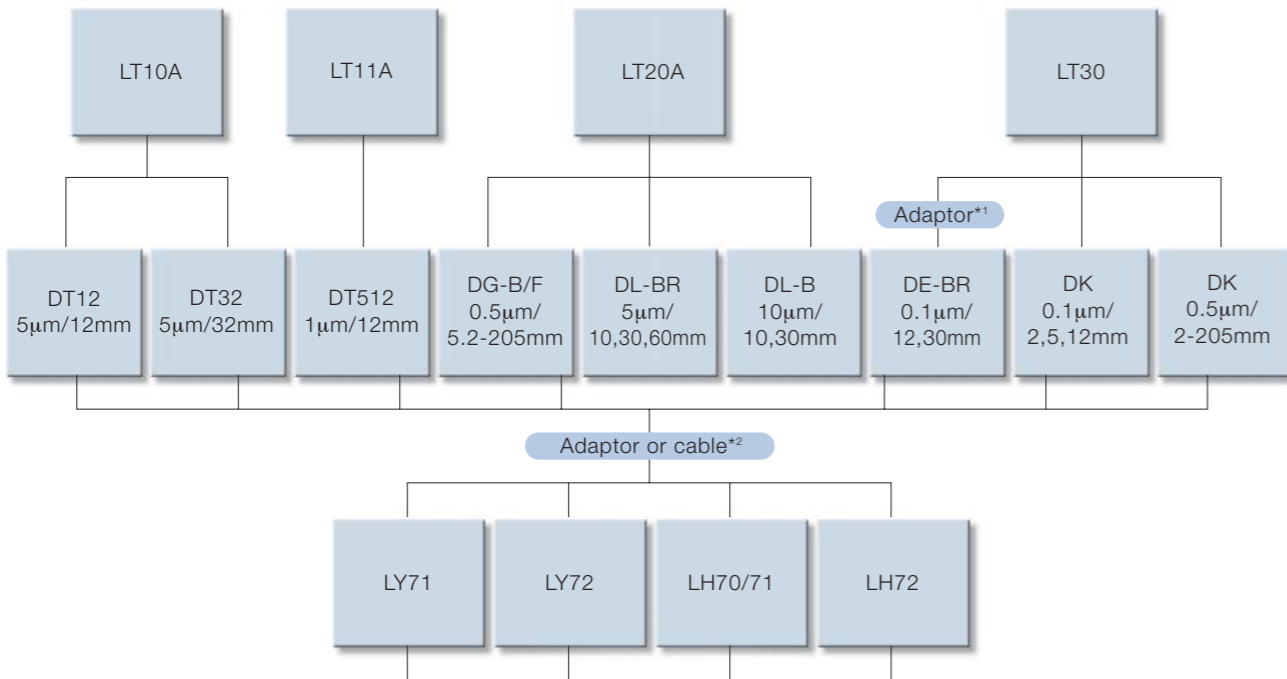

*1: Please see P6-7 "Lineup" about the type name.

*2: Please see P6-7 "Lineup" about the type name.

View in table

Type
Maximum resolution/ effective length

*The standard, the specification, and externals might change without a previous notice for the improvement.

*Please see the end of a book of this catalog for details of the connecting cable.

Gauge

DK802A/B Series	10
DK805A/B Series	11
DK812A/B Series	12
DK10/25 Series	13
DK50/100 Series	14
DK155/205 Series	15
DK110 Series	16
DE-BR Series	20
DG805/DG810 Series	22
DG10B/DG25B Series	23
DG50, DG100, DG155, DG205B Series	24
DG110B	26
DT512N/P Series	30
DT12, 32 Series	31
MT12/13/14	33
DL-B Series	34
U Series	36

DK

DK802A/B Series

High resolution and High accuracy compact digital gauges.

- Measuring range: 2 mm ● Accuracy: 1 μm, 1.5 μm ● Resolution: 0.1 μm, 0.5 μm
- Max. response speed: 80m/min (Resolution: 0.1 μm)
250m/min (Resolution: 0.5 μm)
- Built-in reference point ● Excellent resistance to workshop conditions.
- Robust design for harsh environments.

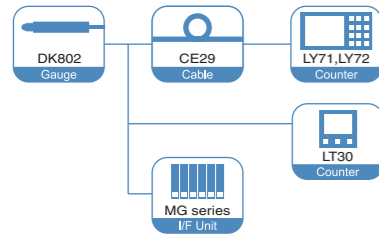

DK802AR/DK802AR5/
DK802BR/DK802BR5

Digital Gauge

Dimensions

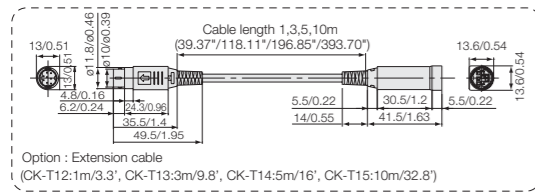
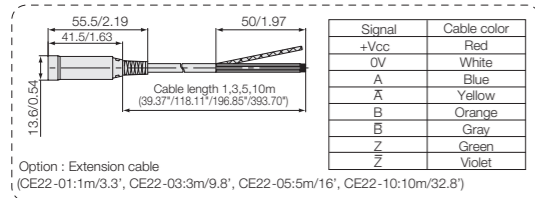

DK802AR/DK802AR5/
DK802BR/DK802BR5

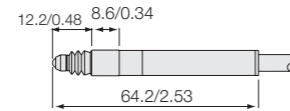

DK802ALR/DK802ALR5/
DK802BLR/DK802BLR5

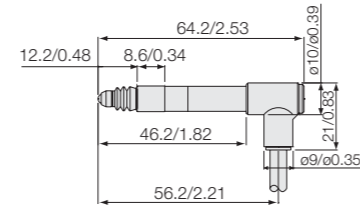

Unit : mm/inch

Specifications DK802 Series

Model	High-resolution Flange models		General-purpose resolution Flange models	
	DK802AR, DK802ALR	DK802BR, DK802BLR	DK802AR5, DK802ALR5	DK802BR5, DK802BLR5
Output	A/B/Z phase voltage-differential line driver output (compliant with EIA-422)			
Signal pitch	40 μm			
Resolution	0.1 μm		0.5 μm	
Measuring range	2 mm (0.08")		5 mm	
Accuracy (at 20°C / 68°F)	1 μm		1.5 μm	
Measuring force (at 20°C / 68°F)	Downward: 0.45 ± 0.25 N Horizontal: 0.40 ± 0.25 N Upward: 0.35 ± 0.25 N			
Reference point	One location (at 1 mm/0.04" position of spindle movement)			
Maximum response speed	80 m/min	42 m/min	250 m/min	100 m/min
Air driving	Vacuum suction (DK802ALR / DK802ALR5 / DK802BLR / DK802BLR5)			
Vibration resistance (10 to 2000 Hz)	100m/s ²			
Impact resistance (11 ms)	1000m/s ²			
Protective structure	IP66 (not including interpolation box and connectors)			
Operating temperature	0°C to 50°C/32°F to 122°F			
Storage temperature	-20°C to 60°C/-4°F to 140°F			
Power supply voltage	DC +5 V ±5%			
Power consumption	1 W			
Cable length	2.5 m/8.2'			
Diameter of stem	φ8 / 0.31" dia.			
Mass ¹	Approx. 20 g/0.7 oz			
Feeler	Provided with a carbide ball tip (DZ-123) Mount screw M2.5		Provided with a steel ball tip Mount screw M2.5	
Accessories	+P M4x5 screw (2pcs.), Installation spacer, Instruction Manual, Supplement			
Output cable length(up to the electronic section)	22 m/72.2' max.			

*1: The mass indicated is the total mass excluding the cable and interpolation box.

DK

DK805A/B Series

High accuracy, compact, and slim gauges suitable for installation on machines.

- Magnetic principle ● Excellent resistance to workshop conditions.
Resistant to oil, water, dust, vibration, and shock. ● Accuracy : 1 μm, 1.5 μm
- Resolution : 0.1 μm, 0.5 μm ● Measuring range: 5 mm
- Low measuring force
- Spindle can be moved vertically with an air pressure device
- Easy installation. Flange type gauges also available.

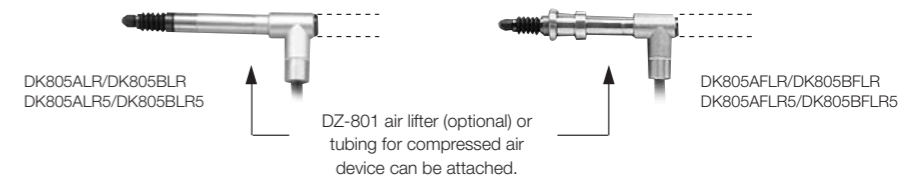
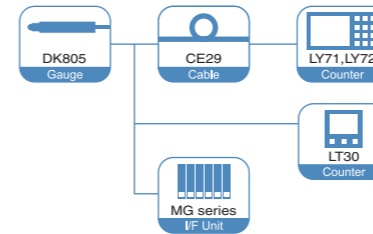

DK805ALR/DK805BLR
DK805ALR5/DK805BLR5

DK805AFLR/DK805BFLR
DK805AFLR5/DK805BFLR5

DZ-801 air lifter (optional) or tubing for compressed air device can be attached.

Digital Gauge

Dimensions

DK805AFLR/DK805BFLR
DK805AFLR5/DK805BFLR5

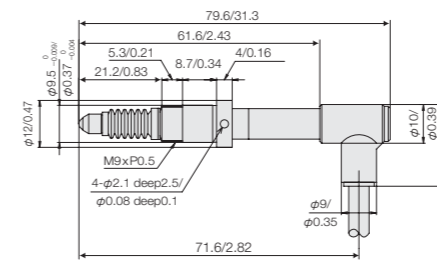

DK805AFLR/DK805BFLR
DK805AFLR5/DK805BFLR5

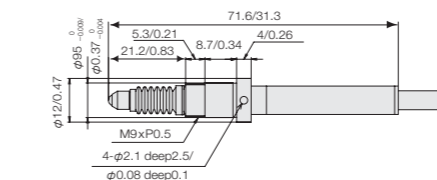

DK805ALR/DK805BLR
DK805ALR5/DK805BLR5

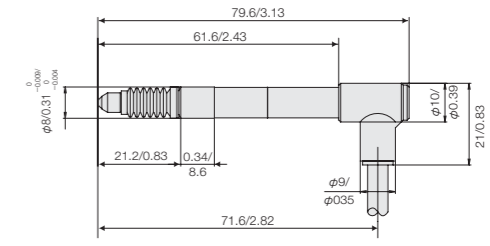

DK805AR/DK805BR
DK805AR5/DK805BR5

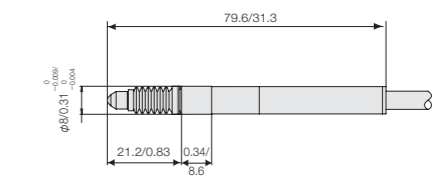

Unit : mm/inch

*Please refer to p54 for the details of the screw.

Specifications DK805 Series

Model	High-resolution models		General-purpose resolution model	
	DK805AFLR, DK805AFLR5, DK805AR, DK805ALR	DK805BFLR, DK805BFLR5, DK805BR, DK805BLR	DK805AFLR5, DK805AR5, DK805ALR5	DK805BFLR5, DK805BR5, DK805BLR5
Output	A/B/Z phase voltage-differential line driver output (compliant with EIA-422) *Please see P17 Output Signal Phase Difference.			
Signal pitch	40 μm			
Resolution	0.1 μm		0.5 μm	
Measuring range	5 mm (0.19")		5 mm	
Accuracy (at 20°C/68°F)	1 μm		1.5 μm	
Measuring force (at 20°C/68°F)	Downward: 0.45 ± 0.25 N Horizontal: 0.40 ± 0.25 N Upward: 0.35 ± 0.25 N			
Reference point	One location (at 1 mm/0.04" position of spindle movement)			
Maximum response speed	80 m/min	42 m/min	250 m/min	100 m/min
Air driving	Vacuum suction (DK805AFLR / DK805AFLR5 / DK805BFLR / DK805BFLR5 / DK805ALR / DK805ALR5 / DK805BLR5)			
Vibration resistance (10 to 2000 Hz)	100 m/s ²			
Shock resistance (11 ms)	1000 m/s ²			
Protective structure	IP66 (not including interpolation box and connectors)			
Operating temperature	0°C to 50°C/32°F to 122°F			
Storage temperature	-20°C to 60°C/-4°F to 140°F			
Power supply voltage	DC +5 V ±5%			
Power consumption	1 W			
Cable length ¹	2.5 m/8.2'			
Diameter of stem	φ 9.50 ±0.009 / 0.37" ±0.0004 dia.			
Mass ²	Approx. 30 g/1.06 oz			
Feeler	Provided with a carbide ball tip (DZ-123) Mount screw M2.5		Provided with a steel ball tip Mount screw M2.5	
Accessories	Installation spacer, Instruction Manual, Supplement			
Output cable length (up to the electronic section)	22 m/72.2' max.			

*1: Please refer to P10 DK 802 A/B about the extension cable (Option).

*2: The mass indicated is the total mass excluding the cable and interpolation box.

DK

DK812A/B Series

High accuracy, rugged gauges.
Suitable for installation on machines.

- Measuring range: 12 mm ● Accuracy: 1 μm, 1.5 μm ● Resolution: 0.1 μm, 0.5 μm
- Max. response speed: 80m/min (Resolution: 0.1 μm)
250m/min (Resolution: 0.5 μm)
- Built-in reference point ● Excellent resistance to workshop conditions.
- Robust design for harsh environments.

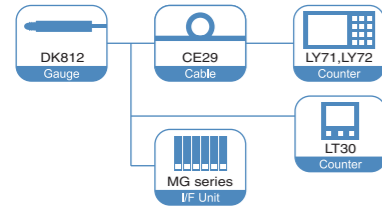

DK812AR/DK812AR5/
DK812BR/DK812BR5

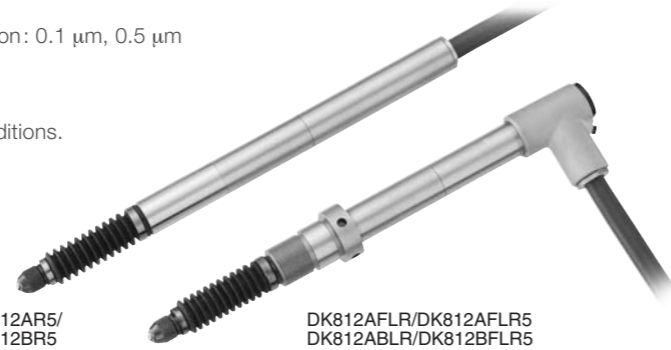

DK812AFLR/DK812AFLR5
DK812ABLR/DK812BFLR5

Digital Gauge

Dimensions

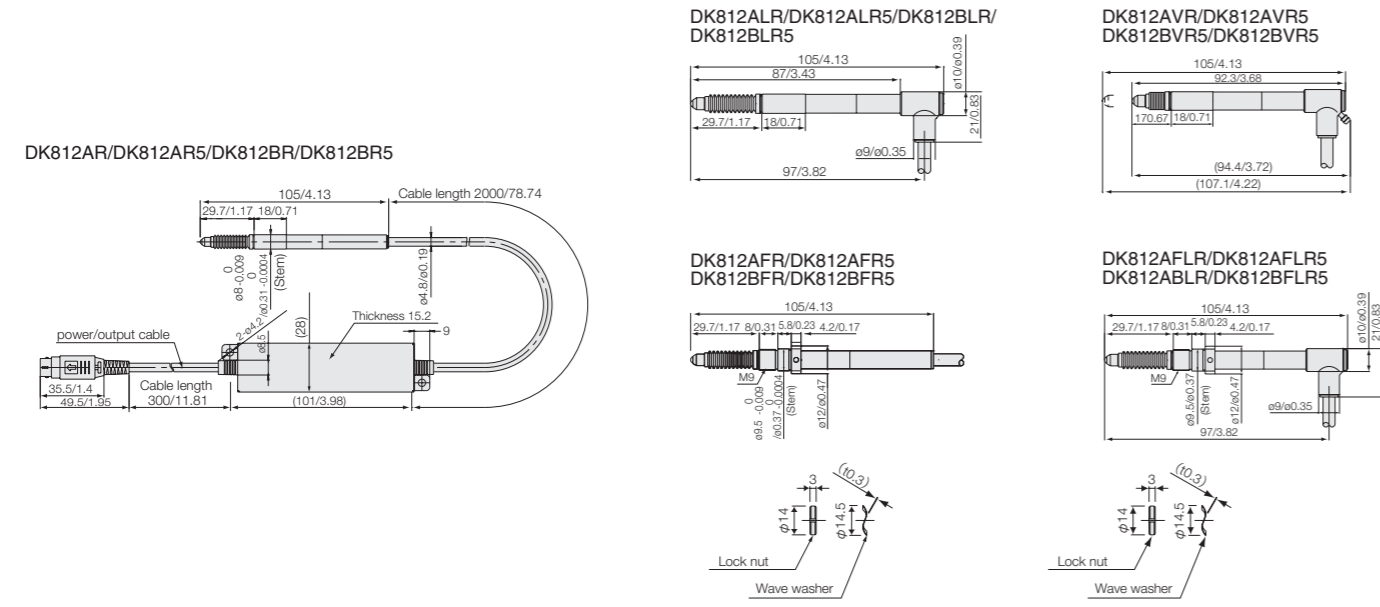

Specifications DK812 Series

Model	High-resolution models		General-purpose resolution models	
	DK812AR, DK812ALR, DK812AFR, DK812AFLR, DK812AVR	DK812BR, DK812BLR, DK812BFR, DK812BFLR, DK812BVR	DK812AR5, DK812ALR5, DK812AFR5, DK812AFLR5, DK812AVR5	DK812BR5, DK812BLR5, DK812BFR5, DK812BFLR5, DK812BVR5
Output	A/B/Z phase voltage-differential line driver output (compliant with EIA-422)			
Signal pitch	40 μm			
Resolution	0.1 μm		0.5 μm	
Measuring range	12 mm (0.47")			
*Accuracy (at 20°C / 68°F)	1 μm		1.5 μm	
Measuring force (at 20°C / 68°F)	Downward: 0.6 ± 0.3 N Horizontal: 0.5 ± 0.3 N Upward: 0.4 ± 0.3 N		Air pressure of 0.03Mpa : 1N or less in all directions Air pressure of 0.04Mpa : 1.7N or less in all directions	
Reference point	One location (at 1 mm/0.04" position of spindle movement)			
Maximum response speed	80 m/min	42 m/min	250 m/min	100 m/min
Air driving	Vacuum suction (DK812AFLR / DK812AFLR5 / DK812BFLR / DK812BFLR5) Pneumatic push type (DK812AVR / DK812AVR5 / DK812BVR / DK812BVR5)			
Vibration resistance (10 to 2000 Hz)	100m/s ²			
Impact resistance (11 ms)	1000m/s ²			
Protective structure	IP66 (not including interpolation box and connectors)			
Operating temperature	0°C to 50°C/32°F to 122°F			
Storage temperature	-20°C to 60°C/-4°F to 140°F			
Power supply voltage	DC +5 V ±5%			
Power consumption	1 W			
Cable length ²	2.5 m/8.2'			
Diameter of stem	φ9.5 ^{0.009} / _{0.37} ⁰ / _{0.0004} dia., φ*8 / 0.31" dia. (Pneumatic push type)			
Mass ¹	Approx. 30 g/1.06 oz			
Feeler	Provided with a carbide ball tip (DZ-123) Mount screw M2.5		Provided with a steel ball tip Mount screw M2.5	
Accessories	+P M4x5 screw (2pcs.), Installation spacer, Instruction Manual, Supplement			
*Output cable length (up to the electronic section)	22 m/72.2' max.			

*1 : Please refer to P10 DK 802 A/B about the extension cable (Option).
*2 : The mass indicated is the total mass excluding the cable and interpolation box.

DK

DK10/25 Series

High accuracy, rugged gauges.
Suitable for installation on machines.

- Measuring range : 10 mm / 0.39" and 25 mm / 0.98" ● Accuracy : 2 μm
- Resolution : 0.5 μm ● Excellent resistance to workshop conditions.
- High measuring force (10PR5/10PLR5/25PR5/25PLR5)
- Low measuring force (10NR5/25NR5/25NLR)
- A variety of accessories available (See "Accessories for Gauges")
- Direct connected to A/B quadrature counter

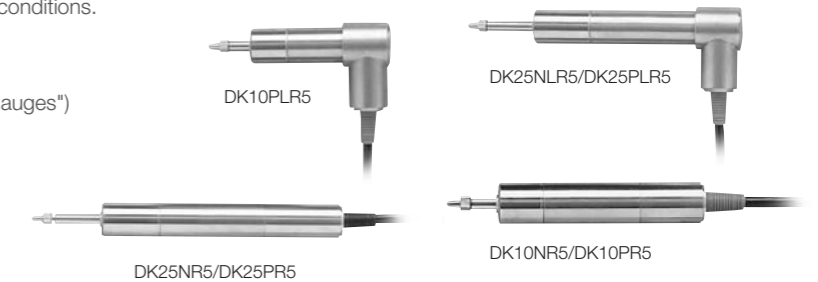
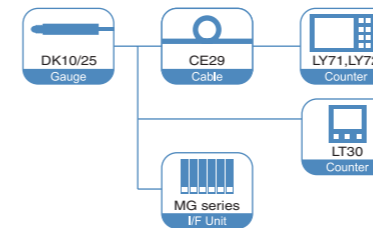

Digital Gauge

Dimensions

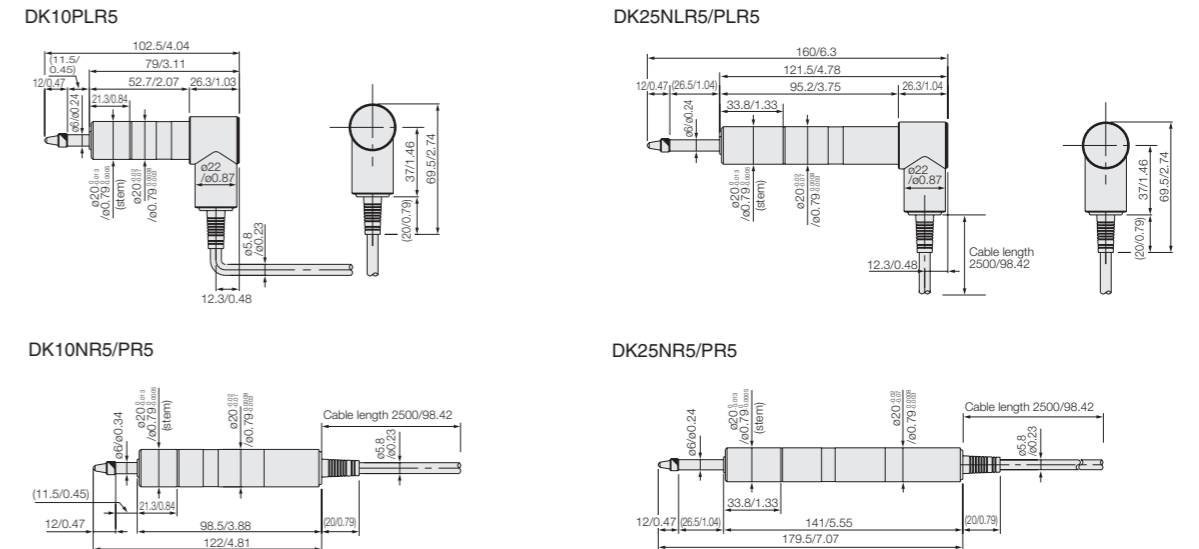

Unit : mm/inch

Specifications

Model	DK10NR5	DK10PR5	DK10PLR5	DK25NR5	DK25PR5	DK25NLR5	DK25PLR5
Output	A/B/Z phase voltage-differential line driver output (compliant with EIA-422) *Please see P17 Output Signal Phase Difference.						
Resolution ¹	0.5 μm						
Measuring range	10 mm			25 mm			
Accuracy (at 20°C)	2 μm						
Measuring force (at 20°C)	Upward: 0.3 ± 0.25 N Horizontal: 0.6 ± 0.3 N Downward: 0.8 ± 0.35 N	4.9 N or less		0.4 ± 0.3 N 0.7 ± 0.35 N	4.9 N or less		0.4 ± 0.3 N 0.7 ± 0.35 N 1 ± 0.4 N
Reference point	One location (at 1 mm position of spindle movement)						
Maximum response speed	250 m/min						
Vibration resistance (10 to 2000 Hz)	150 m/s ²						
Impact resistance (11 ms)	1500 m/s ²						
Protective structure	IP50	IP64		IP50	IP64	IP50	IP64
Operating temperature	0°C to 50°C						
Storage temperature	-20°C to 60°C						
Power supply voltage	DC +5 V ±5%						
Power consumption	1 W or less						
Cable length ²	Approx. 2.5 m						
Diameter of stem	φ20 ^{0.013} / _{0.23} mm						
Mass ³	Approx. 230 g			Approx. 300 g			
Feeler	Provided with a carbide ball tip DZ-122 (Mount screw M2.5)						
Output cable length	22 m max.						
Guaranteed number of Strokes	Minimum 5 million cycles without shock						
Accessories	+P M4x5 screw (2 pcs.), Instruction Manual						

*1 : The resolution setting needs to be made when connecting to the LT30 series, MG series, and LY70 series. For details, please refer to the respective instruction manual.
*2 : Please refer to P10 DK 802 A/B about the extension cable (Option).
*3 : The mass indicated is the total mass excluding the cable and interpolation box.

DK

DK50/100 Series

High accuracy, rugged gauges.
Suitable for installation on machines.

- Measuring range : 50 mm / 1.97", 100 mm / 3.94"
- Accuracy : 2 μm (DK50PR5/50NR5), 4 μm (DK100PR5/100NR5)
- Resolution : 0.5 μm ● Excellent resistance to workshop conditions.
- High measuring force (DK50PR5/100PR5) ● Low measuring force (DK50NR5/100NR5)
- Direct connected to A/B quadrature counter

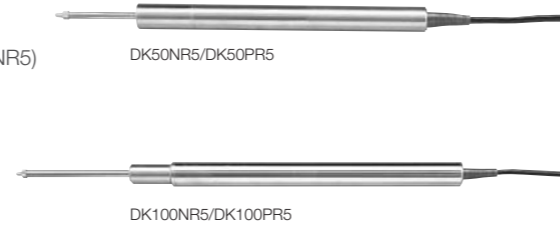
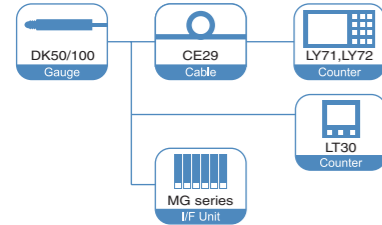

Digital Gauge

Dimensions

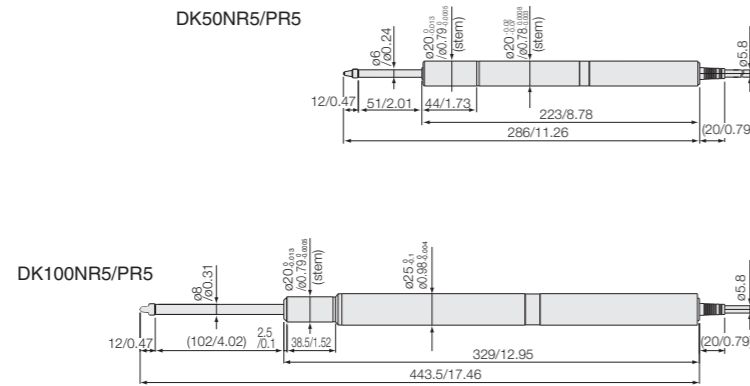

Unit : mm/inch

Specifications				
Model	DK50NR5	DK50PR5	DK100NR5	DK100PR5
Output	A/B/Z phase voltage-differential line driver output (compliant with EIA-422) *Please see P17 Output Signal Phase Difference.			
Resolution*1	0.5 μm			
Measuring range	50 mm		100 mm	
Accuracy (at 20°C)	2 μm		4 μm	
Measuring force (at 20°C)	Upward	—	—	—
	Horizontal	0.9 ± 0.4 N	4.9 N or less	1.8 ± 0.65 N
	Downward	1.3 ± 0.5 N	4.9 N or less	2.7 ± 0.55 N
Reference point	One location (at 1 mm position of spindle movement)			
Maximum response speed	250 m/min			
Vibration resistance (10 to 2000 Hz)	150 m/s ²			
Impact resistance (11 ms)	1500 m/s ²			
Protective structure	IP50	IP64	IP50	IP64
Operating temperature	0°C to 50°C			
Storage temperature	-20°C to 60°C			
Power supply voltage	DC +5 V ±5%			
Power consumption	1 W or less			
Cable length*2	Approx. 2.5 m			
Diameter of stem	ø 20 ⁰ / _{-0.013} mm			
Mass*3	Approx. 360 g		Approx. 630 g	
Feeler	Provided with a carbide ball tip DZ-122 (Mount screw M2.5)			Provided with a carbide ball tip DZ-121 (Mount screw M2.5)
Output cable length	22 m max.			
Guaranteed number of Strokes	Minimum 5 million cycles without shock			
Accessories	+P M4x5 screw (2 pcs.), Instruction Manual			

*1 : The resolution setting needs to be made when connecting to the LT30 series, MG series, and LY70 series. For details, please refer to the respective instruction manual.

*2 : Please refer to P10 DK 802 A/B about the extension cable (Option).

*3 : The mass indicated is the total mass excluding the cable and interpolation box.

DK

DK155/205

High accuracy, rugged gauges.
Suitable for installation on machines.

- Measuring range : 155 mm / 6.1" and 205 mm / 8.07"
- Accuracy : 5 μm (DK155PR5), 6 μm (DK205PR5)
- Resolution : 0.5 μm ● Excellent resistance to workshop conditions.
- Magnet feeler (DG155BP/205BP)
- Direct connected to A/B quadrature counter

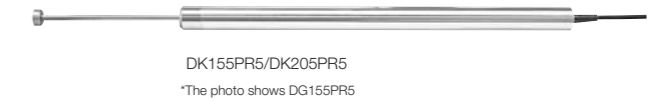
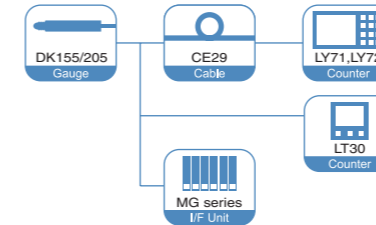

Digital Gauge

Dimensions

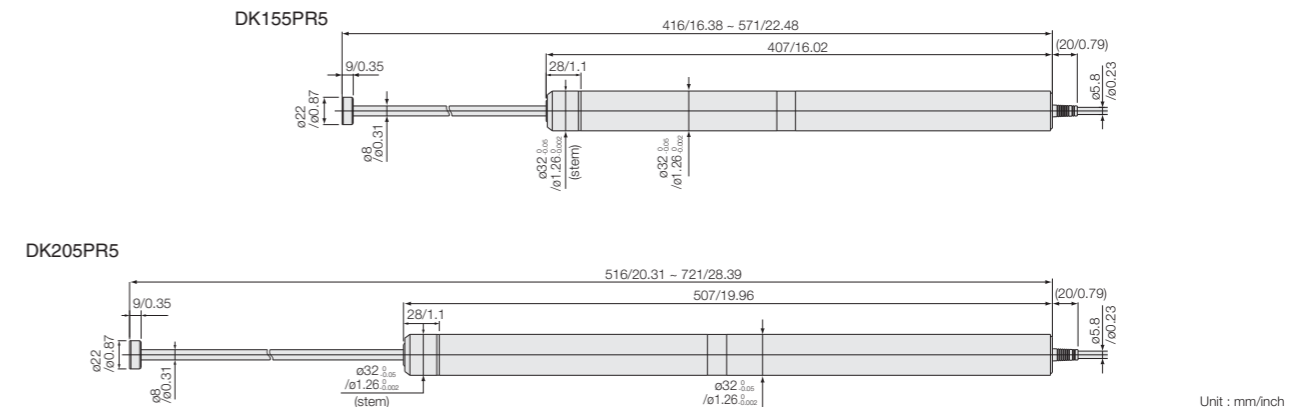

Unit : mm/inch

Specifications		
Model	DK155PR5	DK205PR5
Output	A/B/Z phase voltage-differential line driver output (compliant with EIA-422) *Please see P17 Output Signal Phase Difference.	
Resolution*1	0.5 μm	
Measuring range	155 mm	205 mm
Accuracy (at 20°C)	5 μm	6 μm
Reference point	One location (at 5 mm position of spindle movement)	
Maximum response speed	250 m/min	
Vibration resistance (10 to 2000 Hz)	150 m/s ²	
Impact resistance (11 ms)	1500 m/s ²	
Protective structure	IP64	
Operating temperature	0°C to 50°C	
Storage temperature	-20°C to 60°C	
Power supply voltage	DC +5 V ±5%	
Power consumption	1 W or less	
Cable length*2	Approx. 2.5 m	
Diameter of stem	ø 32 ⁰ / _{-0.05} mm	
Mass*3	Approx. 1100 g	Approx. 1300 g
Feeler mounting base	Magnetic substance	
Magnetically attachable feeler	Magnetic attraction: 10 N, resistance against horizontal slip: 2.7 N Provided with ø4 mm carbide ball tip	
Spindle*4	ø 8 mm, radial swing: 0.04 mm max.	
Output cable length	22 m max.	
Guaranteed number of Strokes	Minimum 5 million cycles without shock	
Accessories	+P M4x5 screw (2 pcs.), Instruction Manual	

*1 : The resolution setting needs to be made when connecting to the LT30 series, MG series, and LY70 series. For details, please refer to the respective instruction manual.

*2 : Please refer to P10 DK 802 A/B about the extension cable (Option).

*3 : The mass indicated is the total mass excluding the cable and interpolation box.

*4 : The spindle weighs about 400g.



- Measuring range :110 mm / 4.33" ● Accuracy: 4 μm ● Resolution: 0.5 μm
- Direct connected to A/B quadrature counter ● Reduced measurement error
- Precision dual spindle support allows for a smooth spindle motion and virtually error free measurements.
- Reduced measuring force
 - The measuring force can be reduced to a minimum of 0.3 N in three selectable steps using the measuring balancer (option). The force is maintained constant regardless of spindle movement direction.
- Soft spindle return. A braking mechanism reduces spindle return speed, thereby eliminating the danger of damaging either the surface plate or the workpiece.

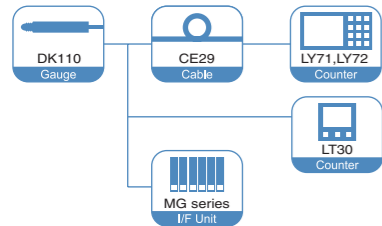

*Digital gauge stand DZ-531 and Measuring force balancer DZ-581 are option.

Digital Gauge

Dimensions

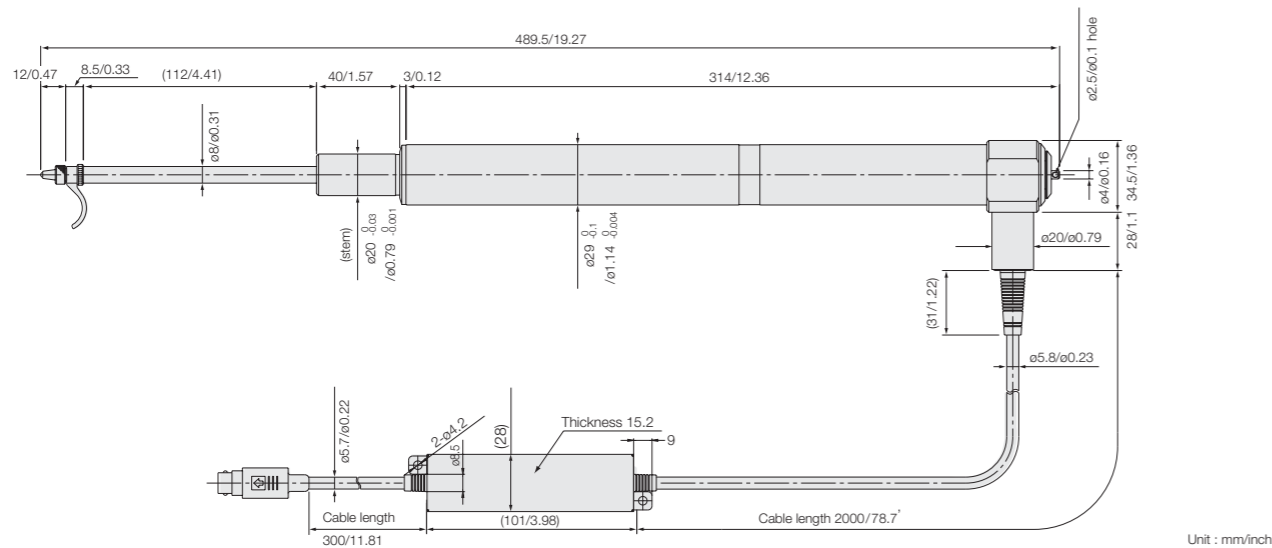

Specifications	
Model	DK110NLR5
Output	A/B/Z phase voltage-differential line driver output (compliant with EIA-422) *Please see P17 Output Signal Phase Difference.
Resolution*1	0.5 μm
Measuring range	110 mm
Accuracy (at 20°C)	4 μm
Reference point	One location (at 5 mm position of spindle movement)
Maximum response speed	250 m/min
Vibration resistance (10 to 2000 Hz)	150 m/s ²
Impact resistance (11 ms)	1500 m/s ²
Protective structure	IP50
Operating temperature	0°C to 50°C
Storage temperature	-20°C to 60°C
Power supply voltage	DC +5 V ±5%
Power consumption	1 W or less
Cable length*2	Approx. 2.5 m
Diameter of stem	ø20 ⁰ / _{0.013} mm
Mass*3	Approx. 800 g
Feeler	DZ-121 (Mount screw M2.5)
Output cable length	22 m max.
Guaranteed number of Strokes	Minimum 5 million cycles without shock
Accessories	+P M4x5 screw (2 pcs.), feeler DZ-121, lift lever DZ-161, Instruction Manual

*1 : The resolution setting needs to be made when connecting to the LT30 series, MG series, and LY70 series. For details, please refer to the respective instruction manual.
 *2 : Please refer to P10 DK 802 A/B about the extension cable (Option).
 *3 : The mass indicated is the total mass excluding the cable and interpolation box.

DK Series operating cautions

In operating the feeler with a vacuum pump, use such an air-pass system as shown in Fig. 1 to enable air driving. The optimum vacuum rate is 0.04 to 0.067MPa. Further, put such an orifice as shown in Fig. 2 on a tube from the air lifter connector to control the air suction and discharge speed. The feeler is lifted at the air discharge to the vacuum pump.

Fig.1 Air-pass System

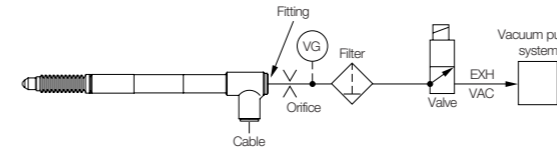
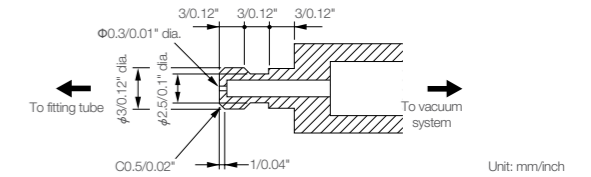
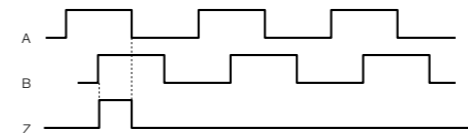

Fig.2 Dimensions of Orifice



DK Series measuring unit output signals

The signals output from this measuring unit are A/B quadrature signal, Z signal in the form of voltage-differential line driver output compliant with EIA-422.



When connecting with MG40 series measuring system, output signal have to change to the serial output from A/B output by a switch on interpolation box.

The reference point is the synchronized reference point that is at Hi impedance when the phase A and phase B are at the Hi level.

DK800A output signals at maximum response speed (at approx. 80 m/min)

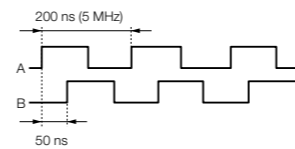

DK800B output signals at maximum response speed (at approx. 42 m/min)

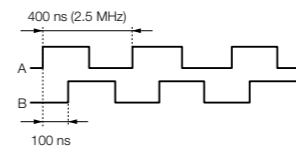

DK10/25/100/155/205/110 Output signals at maximum response speed (at approx. 42 m/min)

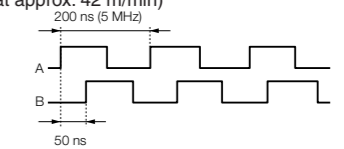

Before using, check that the minimum input phase difference of the control device connected to this measuring unit or the counter is smaller than 50 ns for the DK800A (A signal cycle: 200 ns, 5 MHz) or smaller than 100 ns for the DK800B (A cycle: 400 ns, 2.5 MHz).

Before using, check that the minimum input phase difference of the control device connected to this measuring unit or the counter is smaller than 50 ns for-DK 10-110 series (A signal cycle: 200 ns, 5 MHz).

*The minimum phase difference can be modified under special specifications.

*The minimum phase difference can be modified under special specifications.

Output Signal Phase Difference

The travel amount of the measuring unit is detected every 50 ns for the DK800A and every 100 ns for the DK800B, and the phase difference proportional to the amount traveled is output. The phase difference changes in integer multiples of 50 ns or 100 ns. Also, the minimum phase difference for the A and B is 50 ns for the DK800A and 100 ns for the DK800B.

The travel amount of the measuring unit is detected every 50 ns, and the phase difference proportional to the amount traveled is output. The phase difference changes in integer multiples of 50 ns. Also, the minimum phase difference for the A and B is 50 ns.

DK802A/B-812A/B

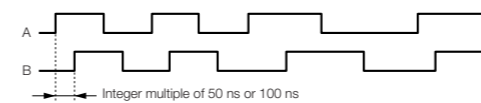

DK10/25/100/155/205/110

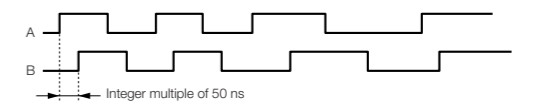

In maximum standard specifications, the minimum phase difference is fixed at 50 ns for the DK800A and 100 ns for the DK800B, but the minimum phase differences in the table below are available as special specifications.

In the standard specifications, the minimum phase difference is fixed at 50 ns, but the minimum phase differences in the table below are available as special specifications.

A/B minimum phase difference	A signal cycle	Counter allowable frequency	Maximum response speed		Remarks
			Resolution 0.1 μm	Resolution 0.5 μm	
50 ns	200 ns	5 MHz	80 m/min	250 m/min	DK800A standard product
100 ns	400 ns	2.5 MHz	42 m/min	100 m/min	DK800B standard product
300 ns	1.2 μs	833 kHz	14 m/min	33 m/min	Special specifications
500 ns	2 μs	500 kHz	8.4 m/min	20 m/min	Special specifications

A/B minimum phase difference	A signal cycle	Counter allowable frequency	Maximum response speed Resolution 0.5 μm	Remarks
100 ns	400 ns	2.5 MHz	100 m/min	Special specifications
300 ns	1.2 μs	833 kHz	33 m/min	Special specifications
500 ns	2 μs	500 kHz	20 m/min	Special specifications

Output Signal Alarm

If the response speed is exceeded, the A/B output from this measuring unit changes to Hi impedance for about 400 ms to serve as an alarm.

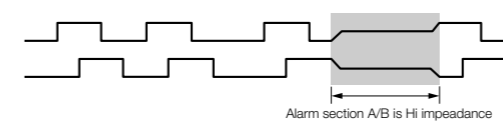

Receiver

DK10/25/100/155/205/110

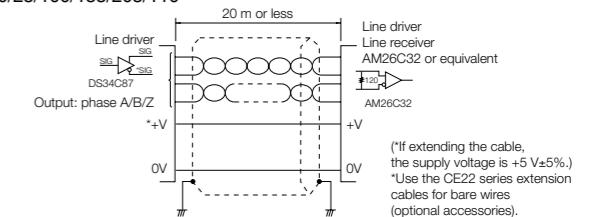

(If extending the cable, the supply voltage is +5 V±5%.)
 *Use the CE22 series extension cables for bare wires (optional accessories).

Accessories (for DK and DG series)

DZ-122 Feeler (for DK Series, DG10B and DG50B)

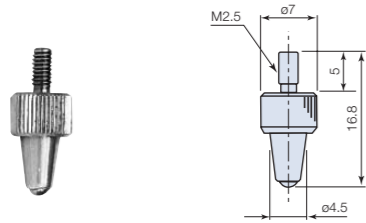

- Contact point: ϕ 2.5 mm/0.098" carbide ball tip (mounting screw: M2.5 x 0.45)

Unit : mm

DZ-123 Feeler (for DK Series, DG805BL/810B/810BL)

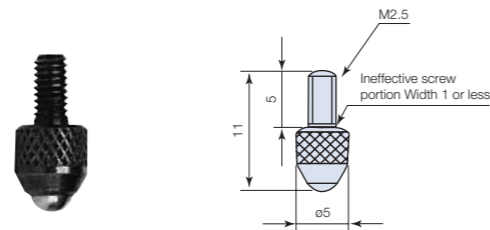

- Contact point: ϕ 3 mm/0.118" carbide ball tip (mounting screw: M2.5 x 0.4)

Unit : mm

DZ-531 Digital gauging stand (for DK110, DG110B)



- Surface plate material: gabbro
- Surface plate flatness: 3 μ m
- Surface plate size: 350mm (13.78") x 350mm (13.78")
- Maximum workpiece height: approx. 330mm (12.99")
- Gauge mounting hole: ϕ 20mm (0.79")
- Mass: 38kg(83.8 lbs)

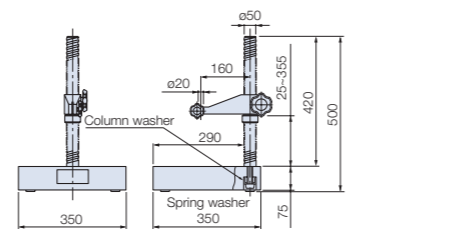

Unit : mm

DZ-581 Measuring force balancer (for DK110, DG110B)

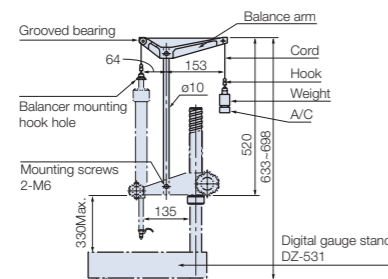

Unit : mm

Weight

- No weight: 1.55 \pm 0.15N(155 \pm 15gf)
- B: 1.0 \pm 0.15N(100 \pm 15gf)
- B+A: 0.7 \pm 0.15N(70 \pm 15gf)
- B+C: 0.3 \pm 0.15N(30 \pm 15gf)

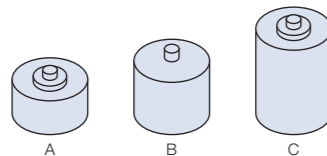

DZ-121 Feeler (for DK100, DG100BP/BN)

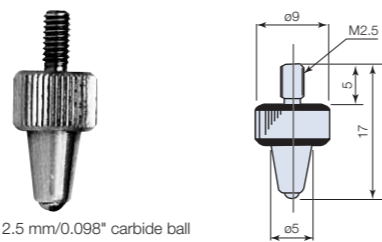

- Contact point: ϕ 2.5 mm/0.098" carbide ball tip (mounting screw: M2.5 x 0.45)

Unit : mm

Other accessories

- CE08 Extension cable : CE08-01 (1m) , 03 (3m) , 05 (5m) , 10 (10m) , 15 (15m)
- CE22 Extension cable (Ahead in pieces) : CE22-01 (1m) , 03 (3m) , 05 (5m) , 10 (10m)
- CK-T Extension cable (Winding-proof) : CK-T12 (1m) , T13 (3m) , T14 (5m) , T15 (10m)

*Please refer to p54 for the details of the screw.

DZ-191 Coupling

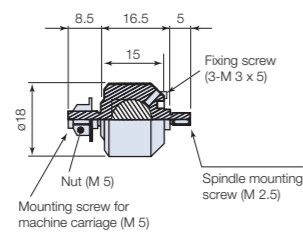

Unit : mm

DE

DE-BR Series

High precision digital gauge for submicron position detection and measuring

- Magnetic principle
- High accuracy: 1 μm
- High resolution: 0.1 μm
- Measuring range: 12 mm / 0.47" and 30 mm / 1.18"
- Built-in zero point
- Protective design grade: equivalent to IP64 with optional bellows.

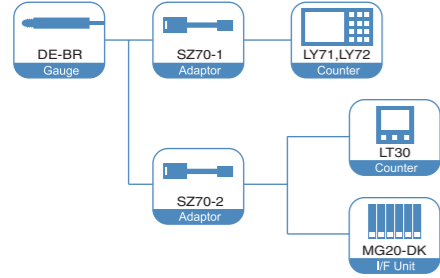

Digital Gauge

Dimensions

DE12BR

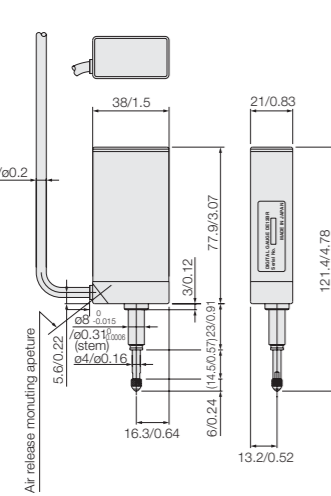

DE30BR

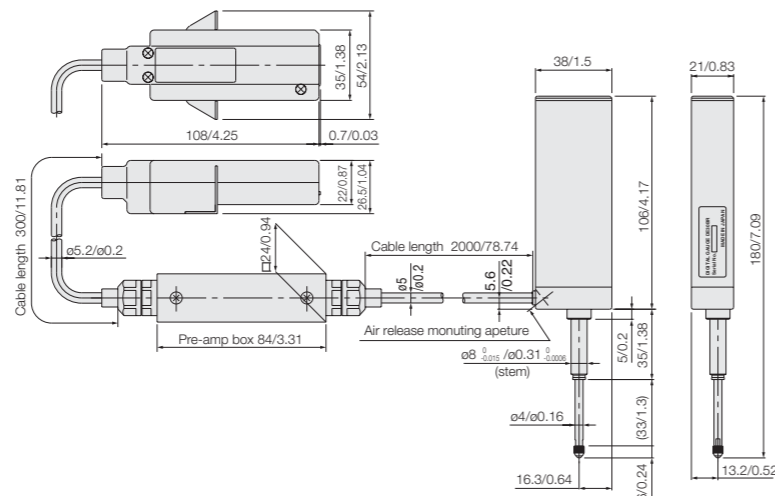

Unit : mm/inch

Specifications		
Model	DE12BR	DE30BR
Measuring range	12 mm / 0.47"	30 mm / 1.18"
Resolution	0.1 μm	
Accuracy (at 20 °C / 68 °F)	1 μm	
Maximum response speed	20 m/min zero point detection mode : 0.15/min	
Measuring force	Upward	0.35 \pm 0.2 N
	Lateral	0.5 \pm 0.2 N
	Downward	0.7 \pm 0.2 N
Zero point	5 mm/0.2" from feeler end fully retracted	
Protective design grade	Equivalent to IP64 (with optional bellows)	
Mounting stem diameter	$\phi 8 \frac{0.015}{0.015} \text{ mm} / \phi 0.31 \frac{0.0008}{0.0008} \text{"$	
Operating temperature	0 °C to 50 °C / 32 °F to 122 °F	
Storage temperature	-10 °C to 60 °C / 14 °F to 140 °F	
Power consumption	$\pm 5\text{V}$ 100mA	
Cable length	2 m / 6.56'	
Feeler	Feeler tipped with 3 mm dia. carbide ball with M2.5p x 0.45 screw on fitting end (DZ123)	
Mass (excl. cable unit)	Approx.400 g / 14.11 oz	Approx.450 g / 15.87 oz

Accessories

DZ301 Bellows set (for DL330B, DE30BR)

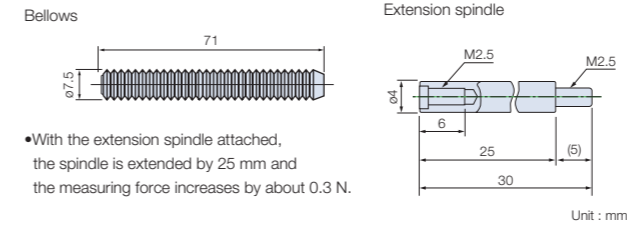

DZ302 Bellows set (for DE12BR)

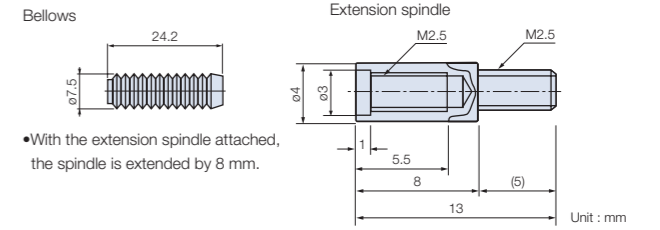

DZ-501 Digital gauging stand (for U60B, DG10B to DG100B, DE-30BR)

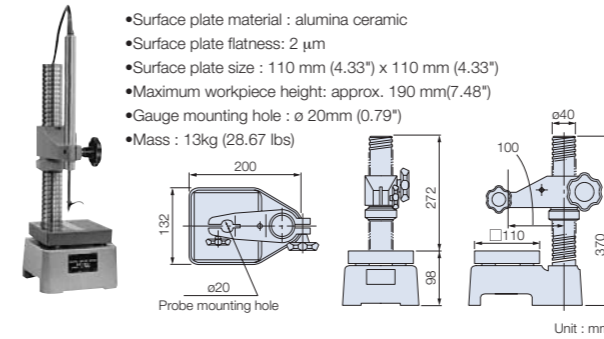

DZ521 Gauging stand (for DG805BL/810B/810BL, U Series, DE12BR)

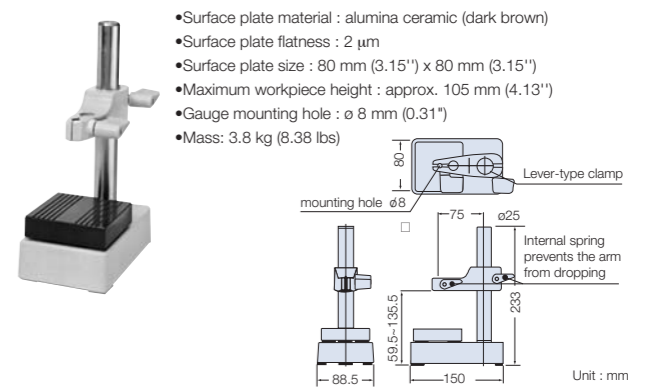

SZ70-1 Adapter

SZ70-1 is required for connecting the following scale units and counters:
 Gauge unit: DE-BR Series, DG-B Series
 Counter: LH71A, LH72-3, LY71 and LY72
 * Adapter DZ51 is also required

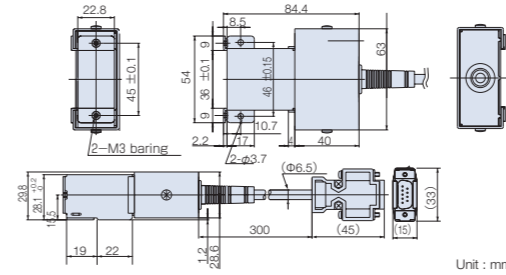

DZ-191 Coupling

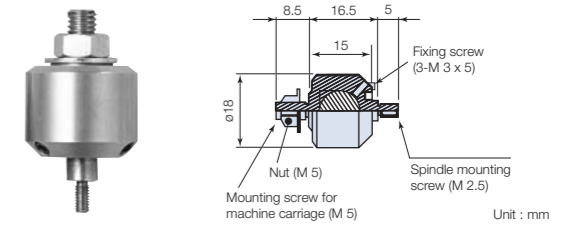

DZ-5100 Feeler set

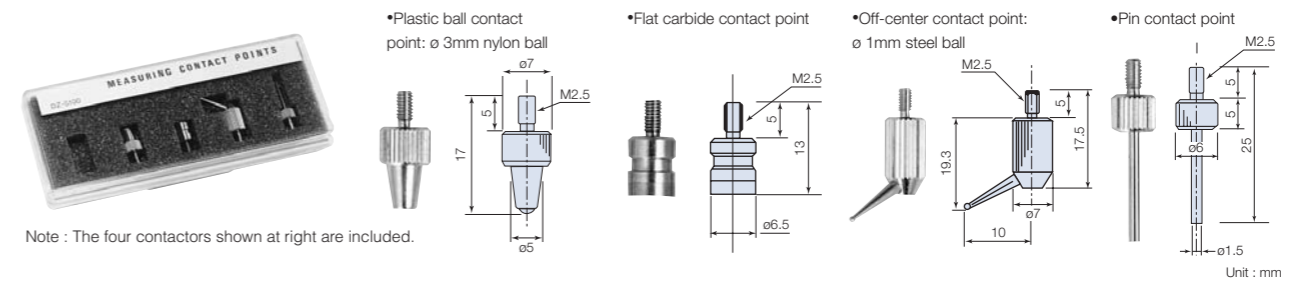

SZ70-2 Adapter

SZ70-2 is required for connecting the following scale units and counters:
 Gauge unit: DE-BR Counterunit: LT30 Interface unit: MG series

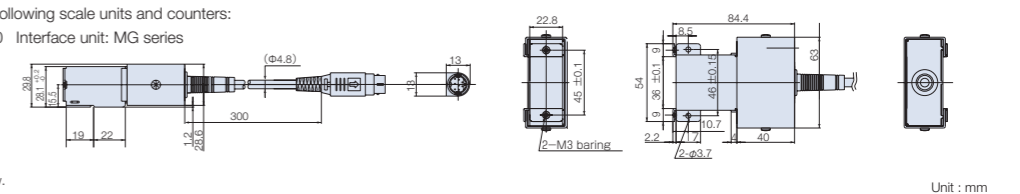

*Please refer to p54 for the details of the screw.

DG

DG805 Series, DG810 Series

High accuracy, compact, and slim gauges suitable for installation on machines.

- Magnetic principle ● Excellent resistance to workshop conditions. Resistant to oil, water, dust, vibration, and shock. ● Accuracy : 2 μm
- Resolution : 0.5 μm ● Measuring range: 5.2 mm / 0.20" and 10 mm / 0.39"
- Compact and slim: ø8 mm / ø0.31" (outer diameter) 74.5 mm / 2.93" (overall length) (DG805)
- Low measuring force
- Spindle can be moved vertically with an air pressure device (DG805BL/FL, DG810BL/FL).
- Dustproof bellows (standard).
- Easy installation. Flange type gauges also available.

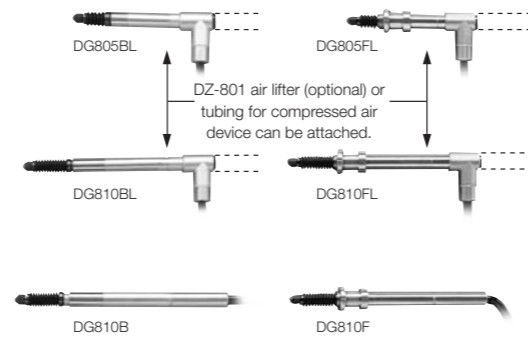
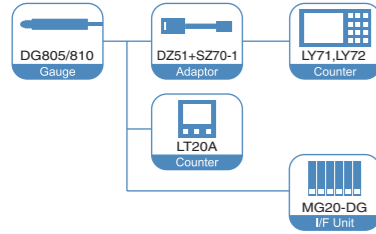

Digital Gauge

Dimensions

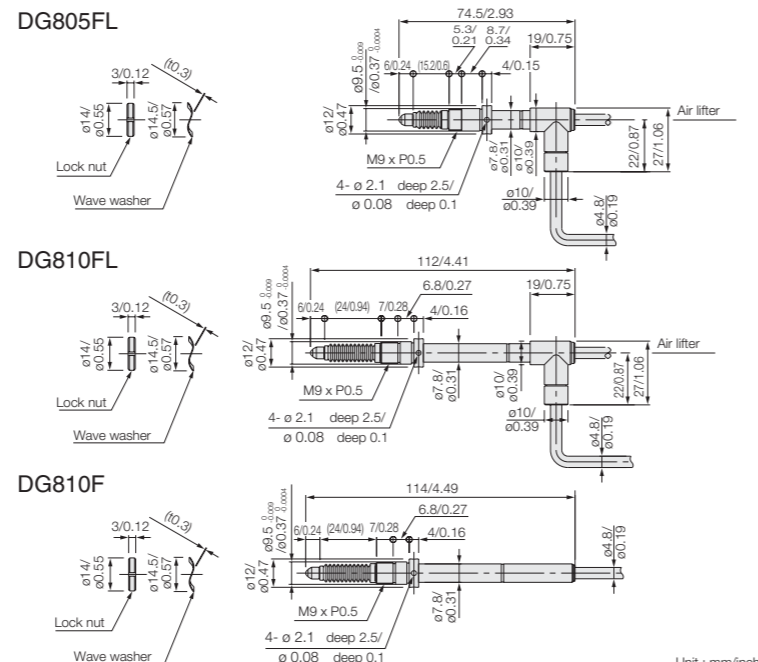
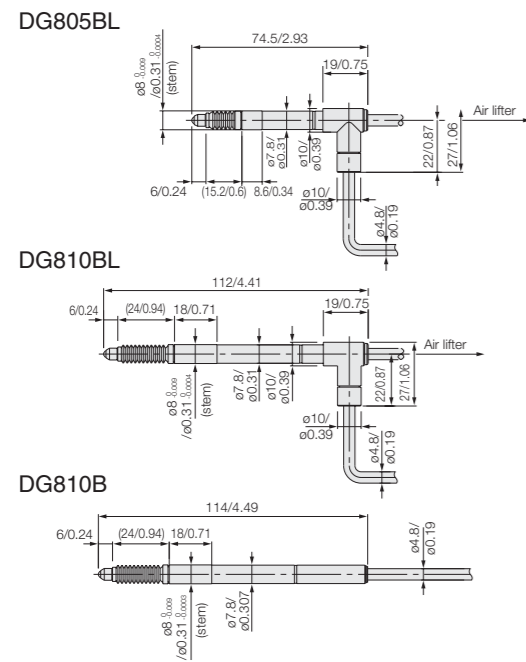

Unit : mm/inch

*Please refer to p54 for the details of the screw.

Specifications

Model	DG805BL / FL / BLM / BLE / FLM / FLE	DG810B / F / BM / BE / FM / FE	DG810BL / FL / BLM / BLE / FLM / FLE
Type	For Counter, A/B quadrature signal output type (See Page 26)		
Measuring range	5.2 mm / 0.20"	10 mm / 0.39"	
Resolution	0.5 μm		
Measuring range force	Upward	0.35 ± 0.25 N	0.4 ± 0.3 N
	Lateral	0.4 ± 0.25 N	0.5 ± 0.3 N
	Downward	0.45 ± 0.25 N	0.6 ± 0.3 N
Accuracy (at 20°C / 68°F)	2 μm		
Maximum Response speed	1m/s		
Operating temperature	0 °C to 50 °C / 32 °F to 122 °F (gauge)		
Storage temperature	-20 °C to 60 °C / -4 °F to 140 °F		
Cable length	5 m / 16.4'		
Mounting stem diameter	ø 8 ^{0.009} mm / ø 0.31 ^{0.0004} " F type: ø 9.5 ^{0.009} mm / ø 0.37 ^{0.0004} "		
Feeler	Feeler tipped with ø 3 mm / 0.12" dia. Carbide ball with M2.5 x 0.45 screw on fitting end (DZ-123)		
Mass*1	Approx.20 g / 0.71 oz	Approx.40 g / 1.41 oz	
Air lifter	Air lifter DZ-801 mountable*2	Air lifter DZ-801 mountable*2	

*1 excl. cable unit and Interpolator unit.

*2 Tubing for compressed air device can be attached.

DG

DG10_B, DG25_B

High accuracy, rugged gauges. Suitable for installation on machines.

- Excellent resistance to workshop conditions (BP/BS : IP64). Resistant to oil, water, dust, vibrations, and shocks.
- Accuracy : 2 μm ● Resolution : 0.5 μm
- Measuring range : 10 mm / 0.39" and 25 mm / 0.98"
- High measuring force (BP/BS)
- Low measuring force (BN/BL) ● Easy installation
- A variety of accessories available (See "Accessories for Gauges")

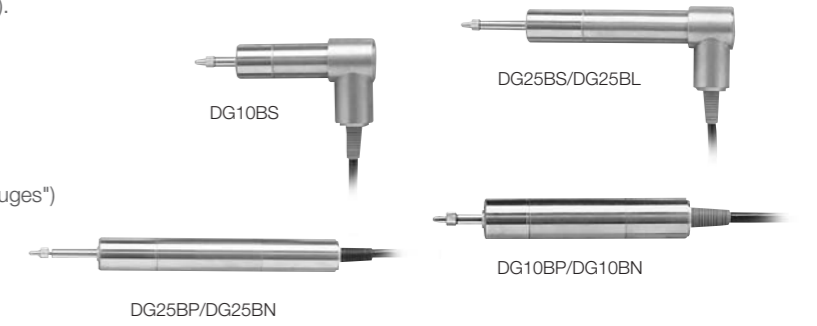
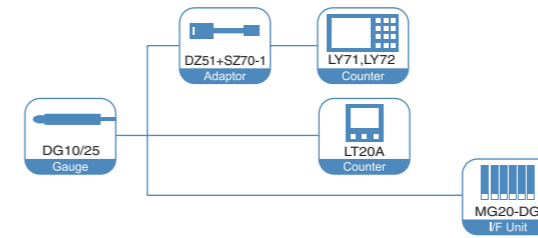

Digital Gauge

Dimensions

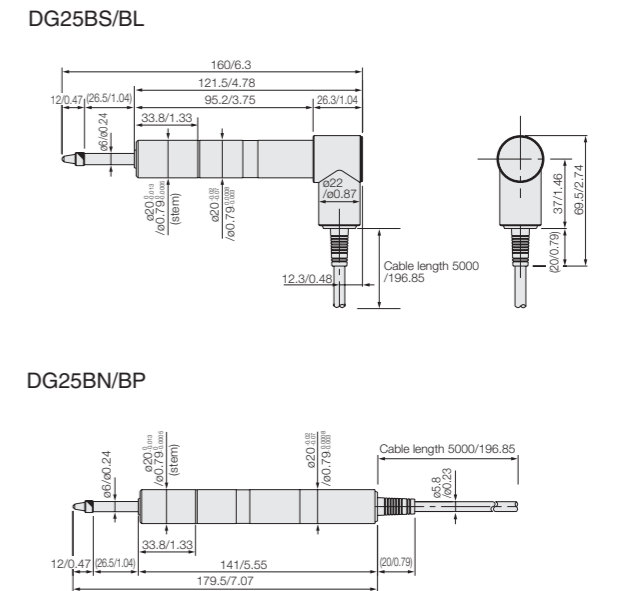
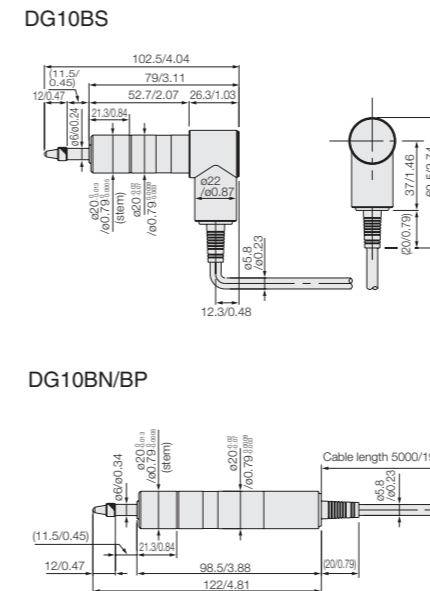

Unit : mm/inch

Specifications

Model	DG10BP / BPM / BPE	DG10BS / BSM / BSE	DG10BN / BNM / BNE	DG25BP / BPM / BPE	DG25BS / BSM / BSE	DG25BN / BNM / BNE	DG25BL / BLM / BLE
Type	For Counter, A/B quadrature signal output type (See Page 26)						
Measuring range	10 mm / 0.39"			25 mm / 0.98"			
Resolution	0.5 μm			0.5 μm			
Measuring range force	Upward	All direction: 4.9 N or less		0.3 ± 0.25 N		0.4 ± 0.3 N	
	Lateral			0.6 ± 0.3 N		0.7 ± 0.35 N	
	Downward			0.8 ± 0.35 N		1 ± 0.4 N	
Accuracy (at 20°C / 68°F)	2 μm						
Maximum Response speed	1m/s						
Operating temperature	0 °C to 50 °C / 32 °F to 122 °F (gauge)						
Storage temperature	-20 °C to 60 °C / -4 °F to 140 °F						
Cable length	5 m / 16.4'						
Mounting stem diameter	ø 20 mm / ø 0.79"						
Feeler	Feeler ø 2.5 mm carbide ball with M2.5p x 0.45 screw on fitting end (DZ-122)						
Protective design grade	Equivalent to IP64		—		Equivalent to IP64		—
Sealing (oil, water, dust)	Oil sealing, O-rings, Y-gaskets		—		Oil sealing, O-rings, Y-gaskets		—
Mass*1	Approx.230 g / 0.507 lbs			Approx.300 g / 0.661 lbs			
Lift lever	—		DZ-161 (option)		—		DZ-161 (option)
Air lifter	—		DZ174-010 (option)*2		—		DZ174-025 (option)*2

*1 excl. cable unit and Interpolator unit.

*2 Tubing for compressed air device can be attached.

DG

DG50_B, DG100_B, DG155_B, DG205_B Series

High accuracy, rugged gauges.
Suitable for installation on machines.

- Excellent resistance to workshop conditions (BP : IP64). Resistant to oil, water, dust, vibrations. and shocks.
- Accuracy: 2 μm (DG50BP/50BN), 4 μm (DG100BP/100BN), 5 μm (DG155BP), 6 μm (DG205BP) ● Resolution : 0.5 μm
- Measuring range: 50 mm / 1.97", 100 mm / 3.94", 155 mm / 6.1" and 205 mm / 8.07"
- High measuring force (DG50BP/100BP) ● Low measuring force (DG50BN/100BN)
- Magnet feeler (DG155BP/205BP) ● Easy installation
- A variety of accessories available (See "Accessories for Gauges")

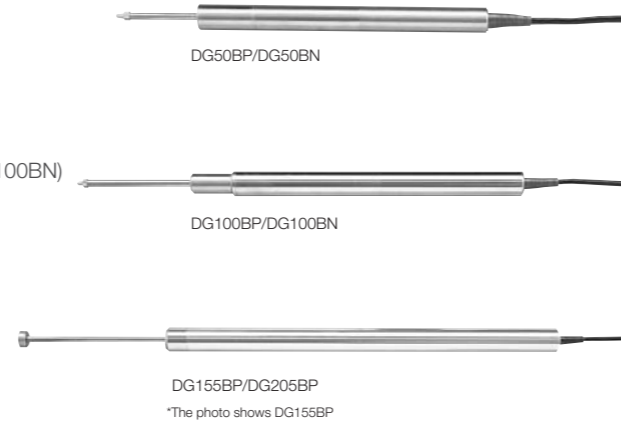
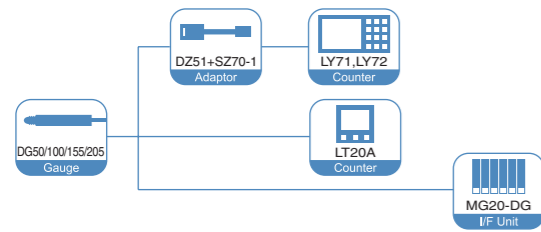

Digital Gauge

Dimensions

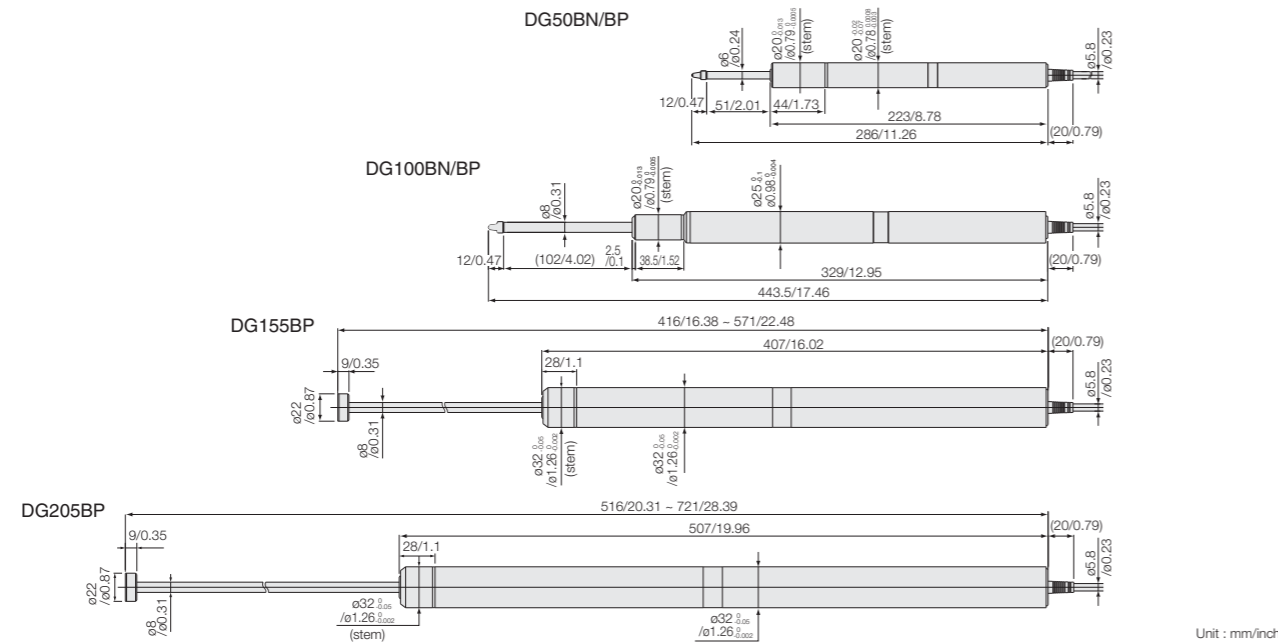

Specifications						
Model	DG50BP BPM/BPE	DG50BN BNM/BNE	DG100BP BPM/BPE	DG100BN BNM/BNE	DG155BP BPM/BPE	DG205BP BPM/BPE
Type	For Counter, A/B quadrature signal output type (See Page 26)					
Measuring range	50 mm/ 1.97"		100 mm/ 3.94"		155 mm/ 6.1"	205 mm/ 8.07"
Resolution	0.5 μm					
Measuring range force	Upward	All direction: 6.2 N or less	All direction : 9.3 N or less	1.8 ± 0.65 N	2.7 ± 0.55 N	—
	Lateral					
	Downward					
Accuracy (at 20°C / 68°F)	2 μm		4 μm		5 μm	6 μm
Maximum Response speed	1m/s					
Operating temperature	0 °C to 50 °C / 32 °F to 122 °F (gauge)					
Storage temperature	-20 °C to 60 °C / -4 °F to 140 °F					
Cable length	5 m/ 16.4'					
Mounting stem diameter	ø 20 ^{+0.013} _{-0.005} mm/ ø 0.79 ^{+0.0005} "			ø 32 (0/-0.05) mm/ ø 1.26* (0/-0.002")		
Feeler	carbide ball tipped feeler (DZ-122)		carbide ball tipped feeler (DZ-121)			
Magnetic feeler	—		—		Attraction force: 10 N(DZ181) Lateral slippage force: 2.7 N	
Protective design grade	Equivalent to IP64		Equivalent to IP64		Equivalent to IP 64	
Sealing (oil, water, dust)	Oil sealing, O-rings, Y-gaskets		Oil sealing, O-rings, Y-gaskets		Oil sealing, O-rings, Y-gaskets	
Mass*1	Approx.360 g/ 0.793 lbs		Approx.630 g/ 1.388 lbs		Approx.1100 g/ 2.425 lbs	Approx.1300 g/ 2.866 lbs
Lift lever	—		DZ-161 (option)		DZ-161 (option)	
Air lifter	DZ174-010 (option)					

DG155BP/205BP does not included the spring. *1 excl. cable unit and interpolator unit *2 Tubing for compressed air can be attached.

DG

DG110_B Series

High accuracy gauge with controllable measuring force

- High accuracy: 4 μm
- Resolution: 0.5 μm ● Measuring range: 110 mm / 4.33" ● Reduced measurement error
- Precision dual spindle support allows for a smooth spindle motion and virtually error free measurements.
- Reduced measuring force
The measuring force can be reduced to a minimum of 0.3 N in three selectable steps using the measuring balancer (option). The force is maintained constant regardless of spindle movement direction.
- Soft spindle return. A braking mechanism reduces spindle return speed, thereby eliminating the danger of damaging either the surface plate or the workpiece.

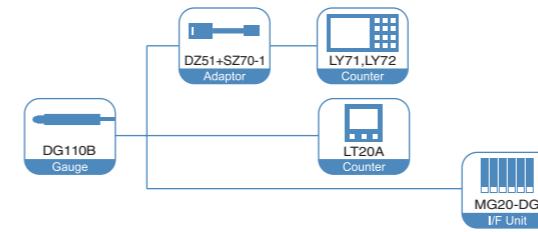

*Digital gauge stand DZ-531 and Measuring force balancer DZ-581 are option.



Digital Gauge

Dimensions

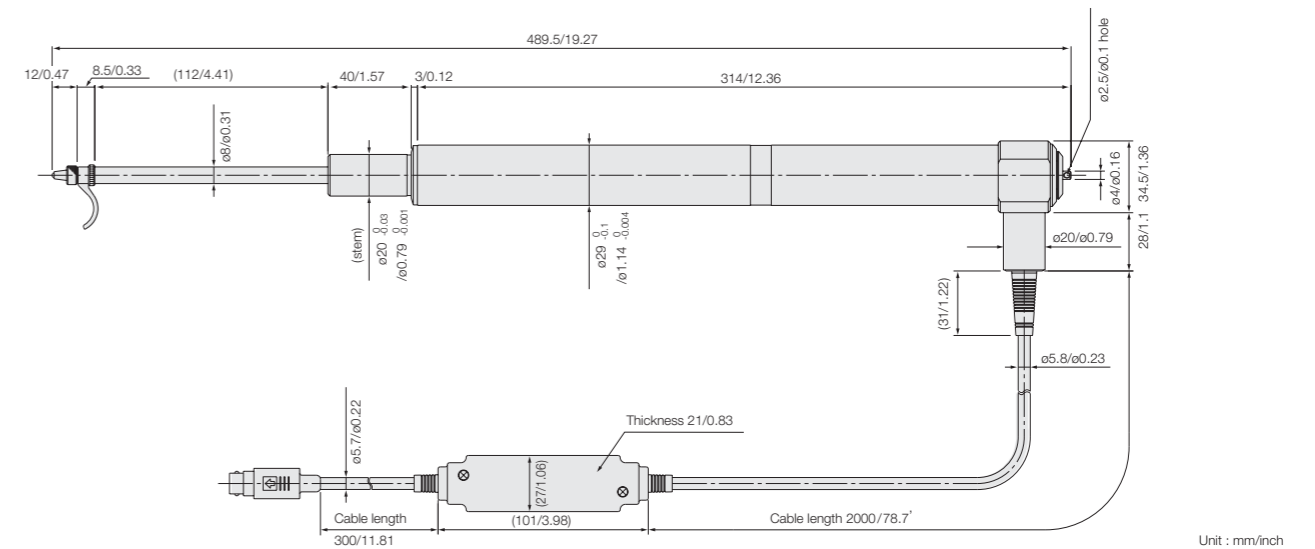

Specifications	
Model	DG110B/BM/BE
Type	For Counter, A/B quadrature signal output type (See Page 26)
Measuring range	110 mm/ 4.33"
Resolution	0.5 μm
Measuring range force	Downward 1.55 ± 0.15 N ²
Accuracy	4 μm
Operating temperature	0 °C to 50 °C / 32 °F to 122 °F
Storage temperature	-10 °C to 60 °C / 14 °F to 140 °F
Cable length	2 m/ 6.56'
Mounting stem diameter	ø 20 ^{+0.013} _{-0.005} mm/ø0.79 ^{+0.0005} "
Feeler	Feeler tipped with ø 2.5 mm/ 0.098" dia. Carbide ball with M2.5p x 0.45 screw on fitting end (DZ-121)
Mass*1	Approx.1150 g/ 2.54 lbs
Lift lever	DZ-161 (supplied)

*1 excl. cable unit and interpolator unit. *2 The measurement force values given apply when DZ-581 measuring force balancer is not used. By using a measuring force balancer (option), it is possible to reduce the measuring force to minimum of 0.3 N. The measuring force will be constant regardless of spindle position.

DG-M/E Type



Outputs

Model	Display connection type						A/B quadrature output type											
	For counter						Power supply output 5V						Power supply 11 to 28V					
	B	BN	BS	BL	F	FL	BM	BNM	BSM	BLM	FM	FLM	BE	BNE	BSE	BLE	FE	FLE
DG805				BL		FL				BLM		FLM				BLE		FLE
DG810	B			BL	F	FL	BM			BLM	FM	FLM	BE		BLE	FE	FLE	
DG10	BP	BN	BS				BPM	BNM	BSM				BPE	BNE	BSE			
DG25	BP	BN	BS	BL			BPM	BNM	BSM	BLM			BPE	BNE	BSE	BLE		
DG50	BP	BN					BPM	BNM					BPE	BNE				
DG100	BP	BN					BPM	BNM					BPE	BNE				
DG155	BP						BPM						BPE					
DG205	BP						BPM						BPE					
DG110	B						BM						BE					

B : Straight BP : Straight/Sealing BN : Straight/Low measuring force BS : L shape/Sealing BL : L shape/Low measuring force F : Straight/Low measuring force/Flange F : L shape/Low measuring force/Flange

Dimensions

Display connection type

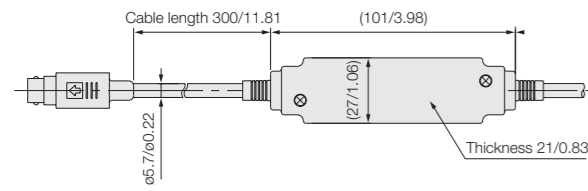

A/B quadrature output type

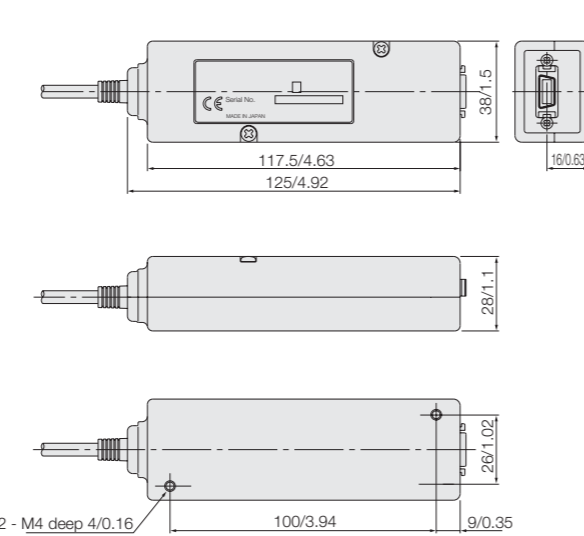

*Build to order for A/B quadrature output type.

Unit : mm/inch

A/B quadrature output type For automatic inspection/measurement in production lines.

- DG-M series for direct AB quadrature output with 5V power supply
- DG-E series for direct AB quadrature output with power supply from 11 to 28V

Specifications

Model	DG□□□M	DG□□□E
Power supply voltage	DC 5V ± 5 % (Correspond to remote sensing function)	DC 11V to 28V (Correspond to remote sensing function)
Power consumption	300 mA (Maximum)	150 mA (Maximum)
Output interface	Based on EIA-422 (Line driver:AM 26C31 or equivalent)	
Output signal	A/B quadrature signal	
Resolution	0.5, 1, 2.5, 10 μm (0.000025", 0.0005", 0.0001", 0.00025", 0.0005") selectable	
Maximum response speed	1 m/s	
Minimum phase difference	200 ns The output phase difference varies with the measuring speed.	
Alarm	A/B quadrature output of this probe turns to high impedance for 10 to 20 ms when excessive speed or cable disconnection alarm occurs. If the cause is removed, the alarm signal is automatically reset.	
Output connector	MDR10214-52A2JL (3M) *	
Dimensions	125 x 28 x 28 (mm) (not including projecting parts)	
Operating temperature	0°C to 40°C / 32°F to 104°F	
Storage temperature	-20°C to 60°C / -4°F to 140°F	
Mass (excl. cable and gauge part)	Approx. 150 g	

*Cable MDR-10114-3000VE (3M)

Accessories (for DGB series)

DZ51 (Relay adapter) For connections of DG-B, DL-BR, DL-B and DT12/32N/P* to LG, LH and LY displays



*To connect the DT12/32N/P, use the DZ51 in combination with the MT10 detector.

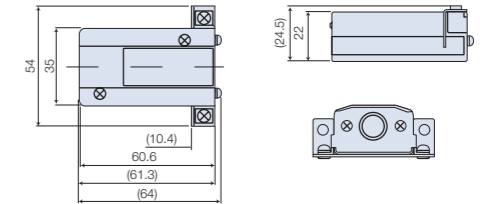

Unit : mm

DZ-501 Digital gauging stand (for DG10B to DG100B, DE-30BR)



- Surface plate material: alumina ceramic
- Surface plate flatness: 2 μm
- Surface plate size: 110 mm (4.33") x 110 mm (4.33")
- Maximum workpiece height: approx. 190 mm (7.48")
- Gauge mounting hole: ø 20mm (0.79")
- Mass: 13kg (28.67 lbs)

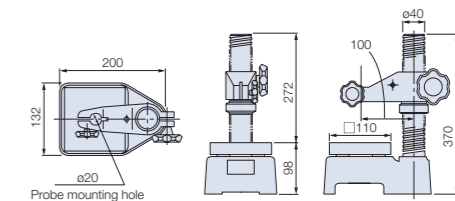

Unit : mm

DZ174-010/025/050 Air lifter (for DG10B to DG50B)

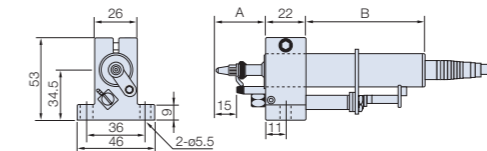
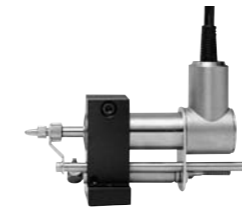

Measuring unit	A	B	Measuring unit	A	B
DG10BP/BN	32.5	75.5	DG25BS	47.5	98.5
DG10BS	32.5	56	DG25BL	47.5	98.5
DG25BP/BN	47.5	118	DG50BP/BN	72	200

Unit : mm

DZ-122 Feeler (for DG10B to DG50B)

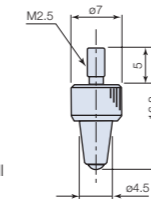

- Contact point: ø 2.5 mm/0.098" carbide ball tip (mounting screw: M2.5 x 0.45)

Unit : mm

DZ-100 Roller feeler (for DT Series, DG-B Series: except for DG155BP/205BP)

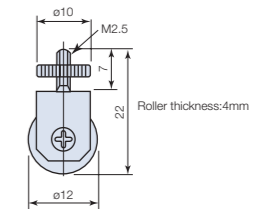

Unit : mm

DZ-181 Magnetic contact point feeler (for DG155BP/205BP)

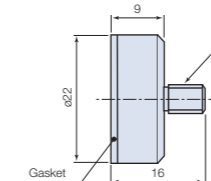

Unit : mm

DZ-191 Coupling

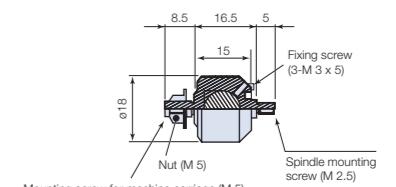

Unit : mm

DZ-801 Air lifter (for DG805BL/810BL)

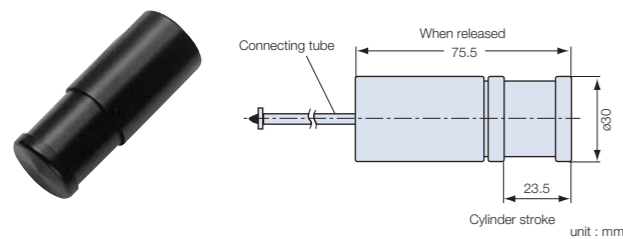

DZ-161 Lift lever (for DG-B except DG155BP/205BP; standard accessory for the DG110B)

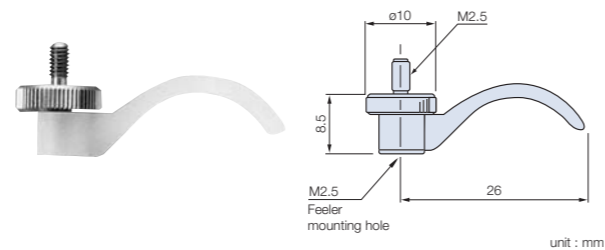

DZ-531 Digital gauging stand (for DK110, DG110B)

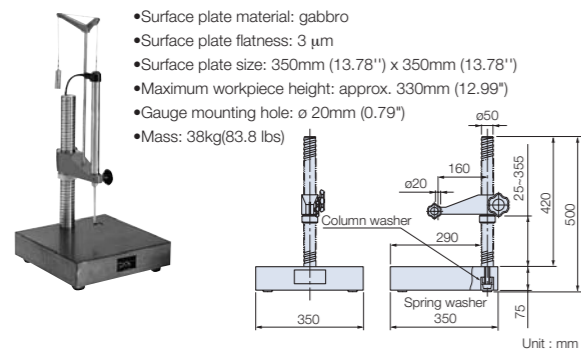

- Surface plate material: gabbro
- Surface plate flatness: 3 μm
- Surface plate size: 350mm (13.78") x 350mm (13.78")
- Maximum workpiece height: approx. 330mm (12.99")
- Gauge mounting hole: φ 20mm (0.79")
- Mass: 38kg(83.8 lbs)

DZ-581 Measuring force balancer (for DK110, DG110B)

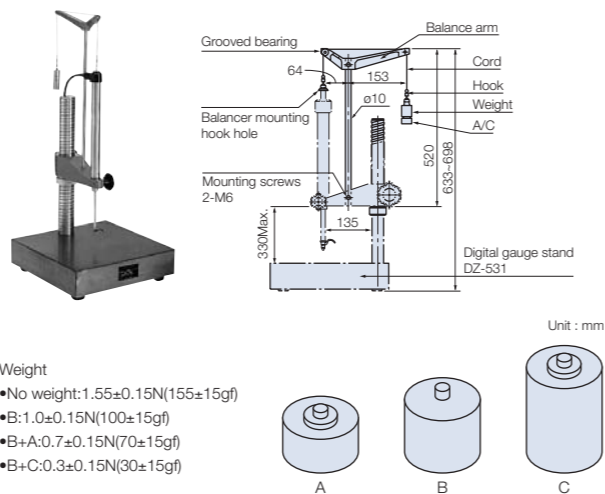

- Weight
- No weight: 1.55±0.15N(155±15gf)
 - B: 1.0±0.15N(100±15gf)
 - B+A: 0.7±0.15N(70±15gf)
 - B+C: 0.3±0.15N(30±15gf)

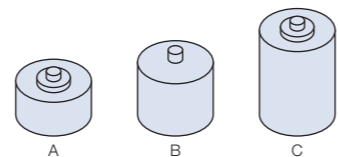

DZ-5100 Feeler set

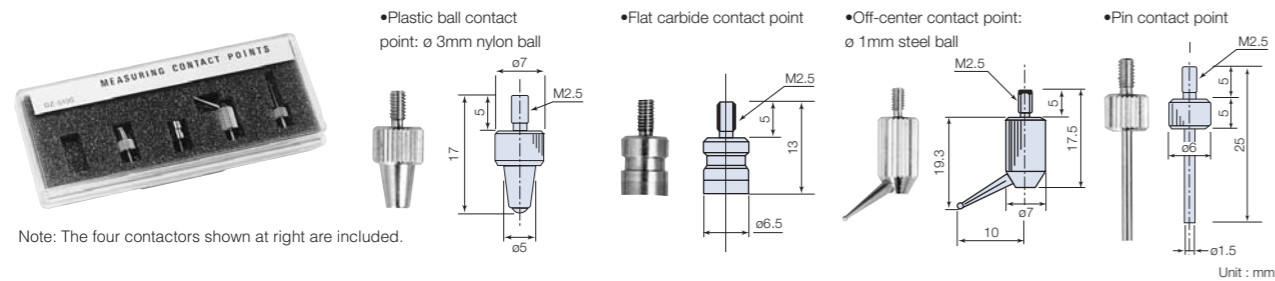

Note: The four contactors shown at right are included.

SZ70-1 Adapter

SZ70-1 is required for connecting the following scale units and counters:

Gauge unit : DE-BR Series, DG-B Series

Counter : LH71A/72, LY71 and LY72

* Adapter DZ51 is also required

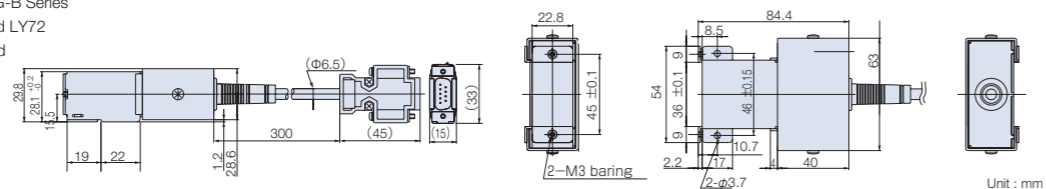

*Please refer to p54 for the details of the screw.

DT

DT512_{N/P}

Compact and slim gauges with 1 μm resolution

- Excellent resistance to workshop conditions (DT512P: IP64)
- Resistant to oil, water, dust, vibration, and shock.
- Accuracy: 6 μm
- Resolution: 1 μm
- Measuring range: 12 mm / 0.47"
- Compact size ideal for designing into machines
12 x 35 x 116 mm / 0.47" x 1.38" x 4.57" (D x W x L)

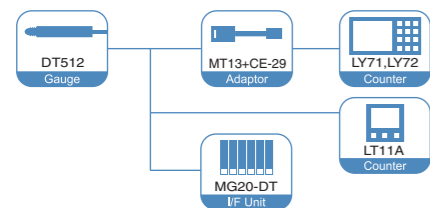

Digital Gauge

Dimensions

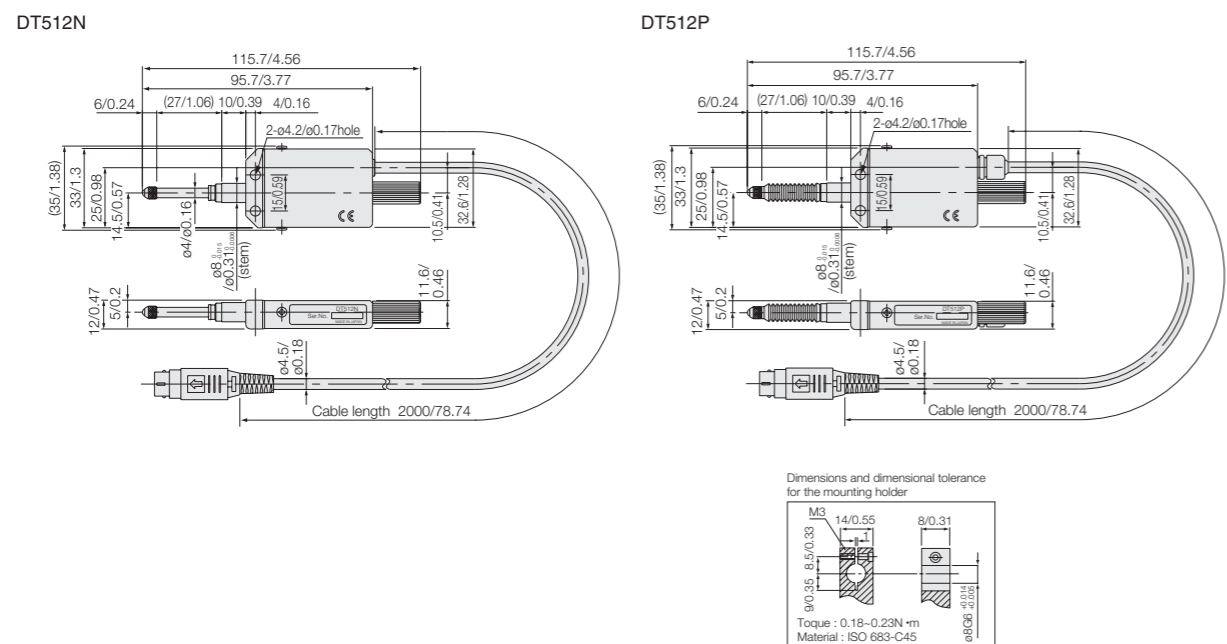

Unit : mm/inch

Specifications		DT512N	DT512P
Model		DT512N	DT512P
Measuring range		12 mm/0.47"	
Resolution		1 μm	
Accuracy (at 20 °C /68 °F)		6 μm	
Measuring force	Upward	0.7 ± 0.5 N	All directions: 1.7 N or less
	Lateral	0.8 ± 0.5 N	
	Downward	0.9 ± 0.5 N	
Protective design grade		Equivalent to IP64	
Operating temperature		0 °C to 50 °C /32 °F to 122 °F	
Storage temperature		-10 °C to 60 °C /14 °F to 140 °F	
Cable length		2 m/6.56'	
Mounting stem diameter		ø 8 ^{0.015} / _{0.00059} mm/ ø 0.31" ⁰ / _{0.00059} "	
Feeler		Feeler tipped with 3 mm dia. steel ball with M2.5p x 0.45 screw on fitting end	
Mass (excl. cable unit)		75 g / 2.65 oz	80 g / 2.82 oz
Guaranteed number of strokes		5 million	

DT

DT12_{N/P}, 32_{N/NV/P/PV}

Compact and slim gauges

- Excellent resistance to workshop conditions (DT12P, DT32P/PV : IP64)
- Resistant to oil, water, dust, vibration, and shock. ● Accuracy : 10 μm
- Resolution : 5 μm ● Measuring range : 12mm/ 0.47", 32mm/1.26"
- Compact size ideal for designing into machines
DT12 : 12(D) x 35(W) x 116(H)mm/ 0.47" x 1.38" x 4.57"
DT32 : 12(D) x 35(W) x 218(H)mm/ 0.47" x 1.38" x 8.58"
- Pneumatic push type are also available ● Guaranteed number of strokes : 5million
- Main applications : Automatic sorting of parts

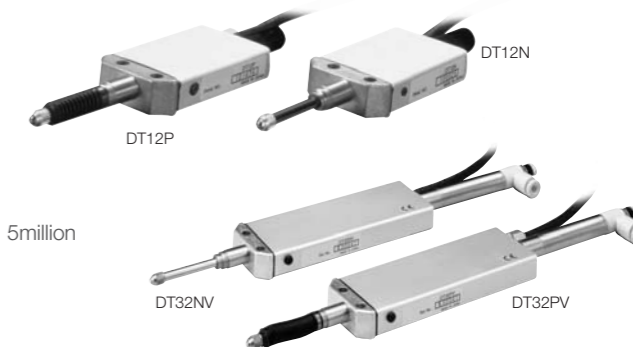
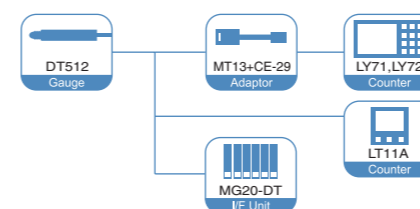

Digital Gauge

Dimensions

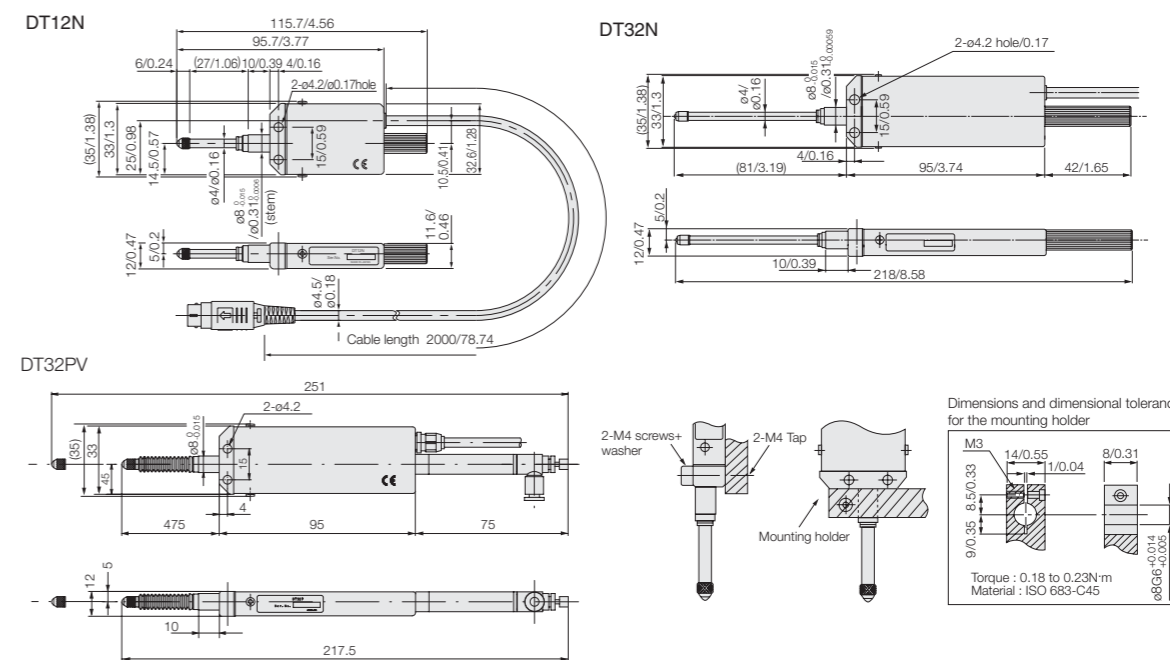

Unit : mm/inch

Specifications		DT12N	DT12P	DT32N	DT32NV	DT32P	DT32PV
Model		DT12N	DT12P	DT32N	DT32NV	DT32P	DT32PV
Spindle actuation		—		Pneumatic push type		Pneumatic push type	
Measuring range		12 mm/ 0.47"		32 mm/ 1.26"			
Resolution		5 μm		5 μm			
Measuring range force	Upward	0.7 ± 0.5 N	All direction: 1.7 N or less	1.1 ± 0.8 N		All direction: 2.9 N or less	
	Lateral	0.8 ± 0.5 N		1.3 ± 0.8 N		All direction: 2.9 N or less	
	Downward	0.9 ± 0.5 N		1.5 ± 0.8 N		All direction: 2.9 N or less	
Accuracy (at 20 °C / 68 °F)		10 μm					
Operating temperature		0 °C to 50 °C / 32 °F to 122 °F (gauge)					
Storage temperature		-10 °C to 60 °C / 14 °F to 140 °F					
Cable length		2 m/ 6.56"					
Mounting stem diameter		ø 8 ^{0.015} / _{0.00059} mm/ ø 0.31" ⁰ / _{0.00059} "					
Feeler		Feeler tipped with ø 3 mm/ ø 0.12" dia. Carbide ball with M2.5p x 0.45 screw on fitting end (DZ-123)					
Mass*1		Approx.75 g/ 2.65 oz	Approx.80 g/ 2.82 oz	Approx.120 g/ 4.23 oz	Approx.140 g/ 4.94 oz	Approx.120 g/ 4.23 oz	Approx.140 g/ 4.94 oz
Protective design grade		—		Equivalent to IP64		Equivalent to IP64	
Guaranteed number of strokes		—		5 million			

*1 excl. cable unit and Interpolator unit.

*2 Measuring force with air pressure of 1.96 x 10⁵ Pa and speed control is open.

*3 Measuring force with air pressure of 2.35 x 10⁵ Pa and speed control is open.

Accessories (for DT series)

DZ176 Air lifter (for DT)



- Measuring range: 0 to 12 mm
- Can be used for DT12/512P/N
- Air pressure: 250 to 700 kPa (25,48 to 69,58 N/cm²)
- Operating temperature: 0 to 50°C
- Storage temperature: -10 to 60°C
- Mass: 41g (incl. speed controller)
- Service life: 5 million times
- Supplied accessories: Mounting jig, speed controller (SMC: AS1211F-M5-04)

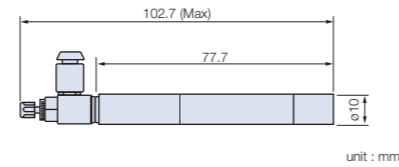

unit : mm

DZ-191 Coupling

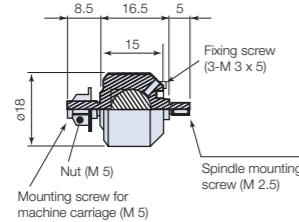

Unit : mm

DZ-100 Roller feeler (for DT Series, DG-B Series: except for DG155BP/205BP)

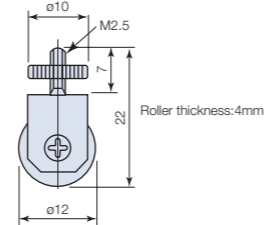

Unit : mm

Other accessories

- CE-08 Extension cable : CE08-01 (1m) , 03 (3m) , 05 (5m) , 10 (10m) , 15 (15m)
- CK-T Extension cable (Ahead-proof) : CK-T12 (1m) , T13 (3m) , T14 (5m) , T15 (10m)
- CK-T101/T105 (Winding-proof) : T101 (3m) , T105 (5m) S

MT

MT12/13/14

Detectors for DT12 / 32 Series

- MT12/13: For connection to counter
- MT14: Unterminated cable
- A/B-quadrature output by line driver [EIA-422 compliance]
- Power supply + 5 V DC

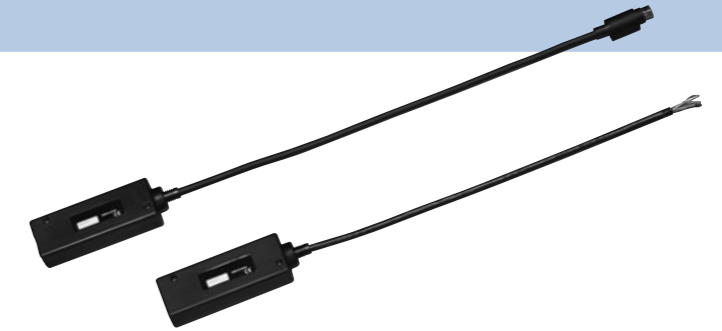
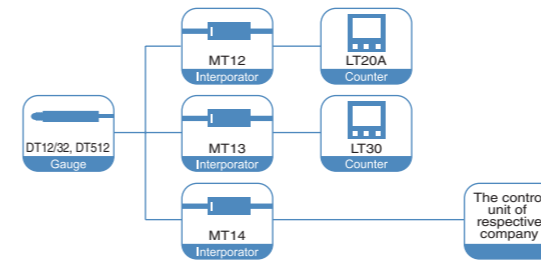

Interpolator

Dimensions

MT12 / MT13

Measuring unit connector

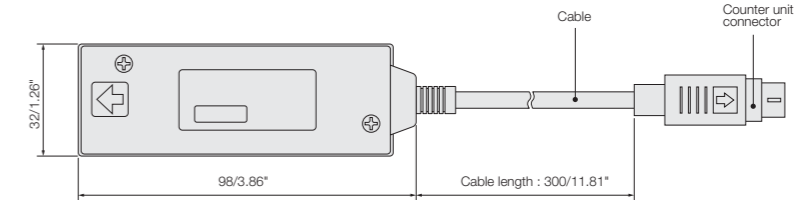
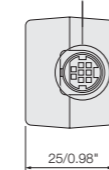

MT14

Measuring unit connector

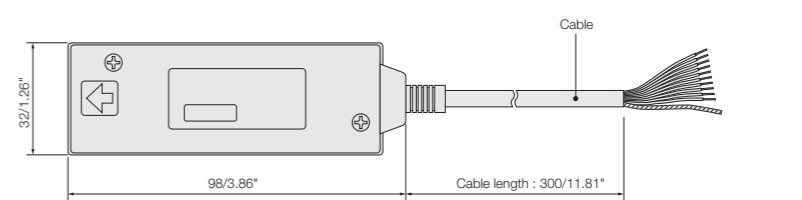
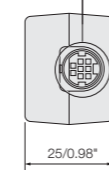

Unit : mm/inch

Phase difference for A/B phase output

Changes as follows according to the traveling velocity of the measuring unit.

Model	MT□□-01	MT□□-05	MT□□-10	Output phase difference (μs)
Velocity (m/min)	0 to 2.5	0 to 12.5	0 to 25	20
	to 6.25	to 31.25	to 62.5	8
	to 12	to 60	to (100)*	5
	to 24	to (100)*	-	2.5
	to 60	-	-	1
	to (100)*	-	-	0.5

* An alarm is output at a traveling velocity of 100 to 115 m/min. The sampling frequency of the output signal is 120 μs.

Pin no.	Description	Cable color
1	+5 V	Red
2	-	-
3	0 V	Black
4	A	Yellow
5	B	Blue
6	-	-
7	-	-
8	ALARM	Gray
9	0 V	Purple
10	0 V	Orange
Case	FG	Shield

Connector used: Hosiden TCP8938 or equivalent product
0V and the shield (FG) are connected with a capacitor.
Nothing should be connected to cables with colors not found in this table.

Pin no.	Description	Cable color
1	+4.5 V	Purple
2	0 V	Black
3	A	Blue
4	Ā	Yellow
5	B	Orange
6	B̄	Gray
7	-	-
8	-	-
Case	FG	Shield

Connector used: Hosiden TCP8938 or equivalent product
0V and the shield (FG) are connected with a capacitor.
Nothing should be connected to cables with colors not found in this table.

Description	Cable color
+5 V	Red
0 V	White
0 V	Brown
0 V	Black
A	Yellow
Ā	Blue
B	Gray
B̄	Orange
ALARM	Purple
ALARM	Green
FG	Shield

0V and the shield (FG) are connected with a capacitor.

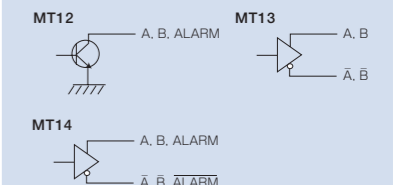

Specifications

Model	MT12-05/10	MT13-01/05/10	MT14-01/05/10
Compatible measuring units	DT12/32, DT512		
Maximum response speed	100 m/min		
Resolution	5μm(-05), 10μm(-10)	1μm(-01), 5μm(-05), 10μm(-10)	
Power voltage	DC5 V ±4 %		
Power consumption	0.9 W	1.2 W (when output load of 120Ω is connected)	
Output format	NPN open collector	Voltage differential line driver	
Operating temperature and humidity range	0 to +50 °C (no condensation)		
Storage temperature and humidity range	-10 to +60 °C (20 to 90 %RH)		
Dimensions	See the Dimensional Diagram.		
Mass	About 90 g		

*Please refer to p54 for the details of the screw.

- Magnetic principle
- Excellent resistance to workshop conditions (DL310B: IP64). Resistant to dust and vibrations.
- Compact size ideal for designing into machines.
- A/B phase output by open collector
- Measuring range: 10 mm / 0.39" and 30 mm / 1.18"

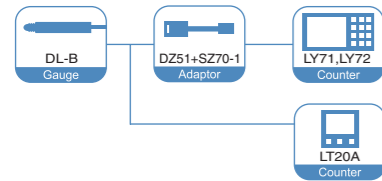

Digital Gauge

Dimensions

DL310B

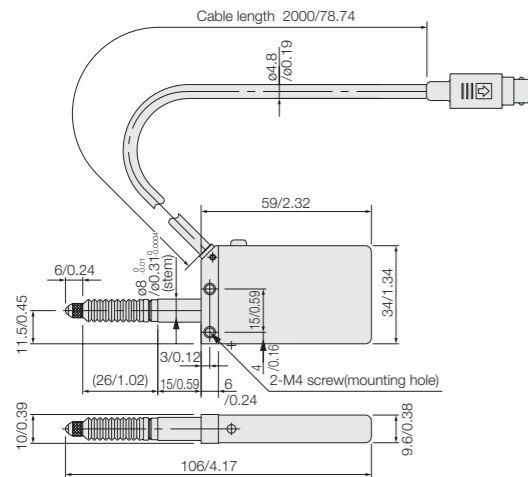

DL330B

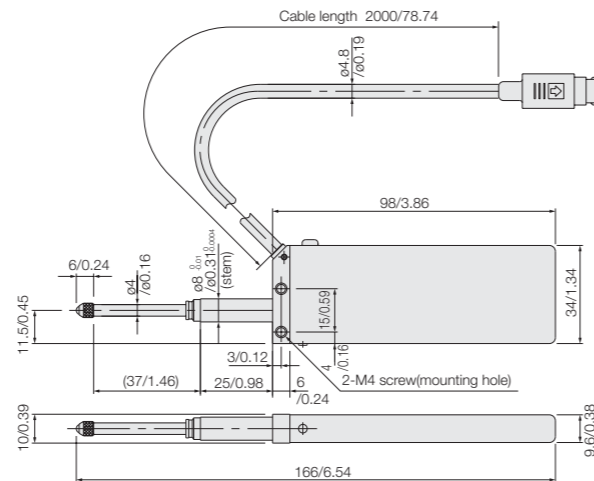

Unit : mm/inch

Specifications

Model	DL310B	DL330B
Measuring range	10 mm/ 0.39"	30 mm/ 1.18"
Resolution	10 μm	10 μm
Accuracy (at 20 °C / 68 °F)	10 μm	10 μm
Measuring force	1.5 N or less	1.5 N or less
Output signal	A/B phase by NPN open collector (12 VDC, 10 mA or less)	
Maximum response speed*1	120 m/ min	
Protective design grade	Equivalent to IP 64	
Mounting stem diameter	ø 8 ^{+0.01} mm / ø 0.31 ^{+0.0004} "	
Operating temperature	0 °C to 50 °C / 32 °F to 122 °F	
Storage temperature	-10 °C to 60 °C / 14 °F to 140 °F	
Power supply	5 VDC ± 5%	
Power consumption	0.2 W	
Cable length	2 m / 6.56 ⁺²	
Feeler	Feeler tipped with 3 mm dia. carbide ball with M2.5 x 0.45 screw on fitting end (DZ123)	
Mass (excl. cable unit)	60 g / 2.12 oz	90 g / 3.17 oz
Vacuum pressure for Air lifter	6.0 x 10 ⁴ to 7.5 x 10 ⁴ Pa	—

*1: Max. response speed of the electrical circuit.

*2: Please consult our sales for more than 2m.

*Consult us when using DL310B/ 330B with the probe facing upward.

Accessories

DZ51 (Relay adapter) For connections of DG-B, DL-BR, DL-B and DT12/32N/P* to LG, LH and LY displays



*To connect the DT12/32N/P, use the DZ51 in combination with the MT10 detector.

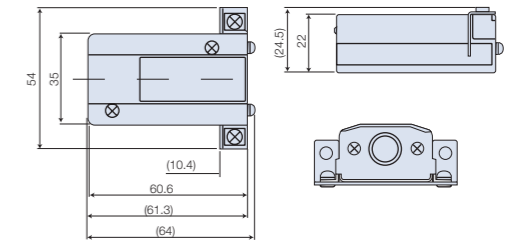

Unit : mm

DZ-811 Bushing (for mounting a U60A or a DE30BR to a DZ-501 stand)

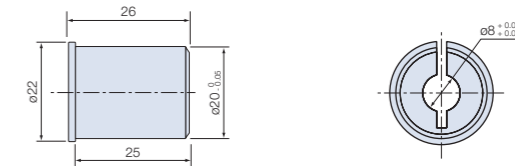

Unit : mm

DZ173 Air release (for DE12BR/30BR, U Series)

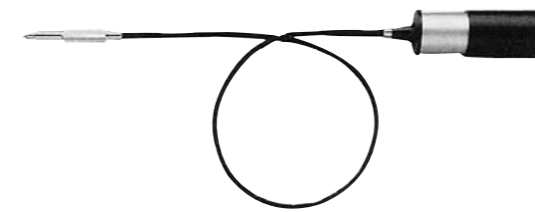

DZ175-010 Air Lifter (for DL10BR) -030 (for DL30BR) -060 (for DL60BR)

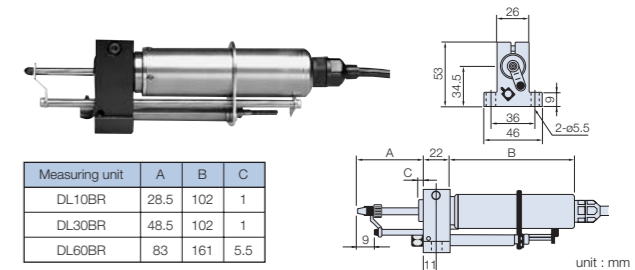

Unit : mm

DZ301 Bellows set (for DL330B, DE30BR)

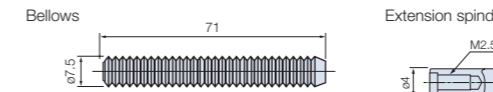

Extension spindle

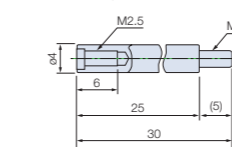

•With the extension spindle attached, the spindle is extended by 25 mm and the measuring force increases by about 0.3 N.

Unit : mm

DZ-191 Coupling

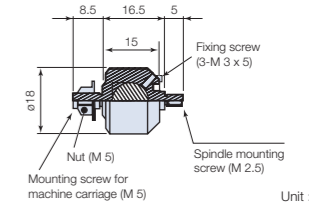

Unit : mm

SZ70-1 Adapter

SZ70-1 is required for connecting the following scale units and counters:

Gauge unit: DE-BR Series, DG-B Series

Counter: LY71 and LY72

* Adapter DZ51 is also required

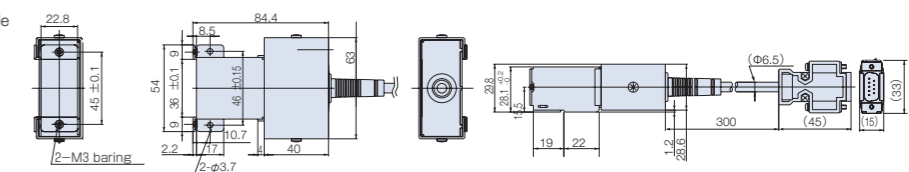

Unit : mm

*Please refer to p54 for the details of the screw.

U

U Series

Easy to operate, high-accuracy digital indicator available in a wide measuring range.

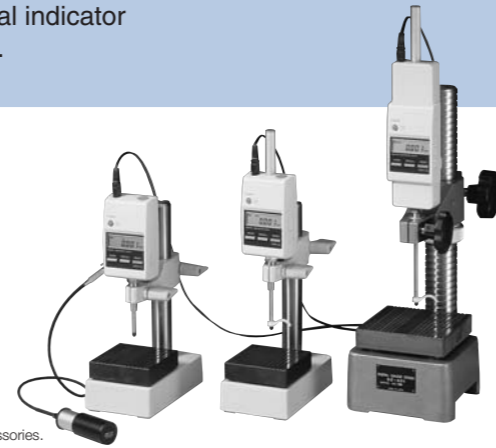

Digital Indicators

- High accuracy: 2 μm (U12B/ 30B)
3 μm (U60B)
- High resolution: 1 μm
- Measuring range: 0 to 60 mm / 0 to 2.36"
- Connectable to a personal computer through RS-232C interface.
- Peak hold for measuring max./ min./ peak-to-peak values
- The spindle contains a damper mechanism to protect measured objects from damage (U30B/ U60B).
- Inch/ metric display

*The air release and the gauging stand are optional accessories.
*Set bushing DZ-811 is required to use U60B with gauging stand DZ-501.

Dimensions

U12B

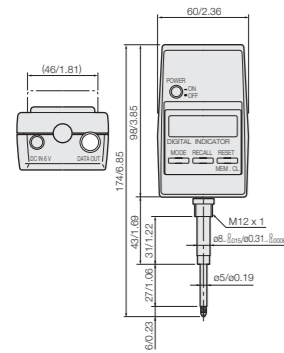

U30B

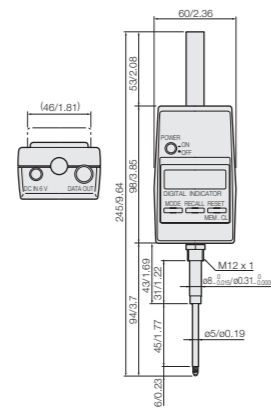

U60B

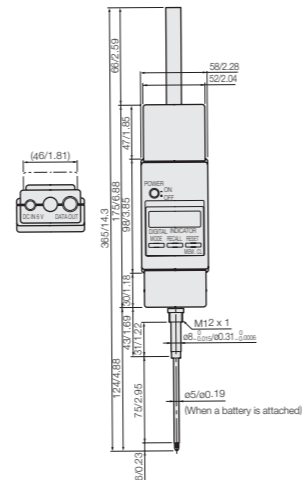

Unit : mm/inch

Specifications

Model	U12B	U30B	U60B
Display	6-digit LCD display, mode indication (leading zero suppress, floating minus sign)		
Measuring range	12 mm / 0.47"	30 mm / 1.18"	60 mm / 2.36"
Resolution	1 μm		3 μm
Accuracy (at 20 °C / 68 °F)	2 μm		
Reset	By key operation		
Direction	Selectable		
Peak hold function	Max./ min./ peak-to-peak values		
Measuring force	1.3 N or less	1.5 N or less	2.2 N or less
Travel length of the release*1	Full stroke	Full stroke	32mm
Maximum response speed	24 m / min		
Output signal	RS-232C (2400 bps)		
Mounting stem diameter	ø 8.0 ^{+0.015} mm / ø 0.31 ^{+0.0006} "		
Operating temperature/humidity	0 °C to 40 °C / 32 °F to 104 °F (non condensing)		
Storage temperature/humidity	-10 °C to 50 °C / 14 °F to 122 °F (non condensing)		
Power supply	AC adaptor: AC 100V 50/60Hz		
Feeler	Feeler tipped with 3 mm dia. carbide ball with M2.5p x 0.45 screw on fitting end (DZ123)		
Supplied accessories	lift lever wrench		
Mass	Approx.190 g / 6.7 oz	Approx.230 g / 8.11 oz	Approx.300 g / 10.58 oz

*1 When air release DZ-173 (optional accessory) is activated

Accessories (for U series)

DZ521 Gauging stand (for DG805BL/810B/810BL, U Series, DE12BR)



- Surface plate material: alumina ceramic (dark brown)
- Surface plate flatness: 2 μm
- Surface plate size: 80 mm (3.15") x 80 mm (3.15")
- Maximum workpiece height: approx. 105 mm (4.13")
- Gauge mounting hole: ø 8 mm (0.31")
- Mass: 3.8 kg (8.38 lbs)

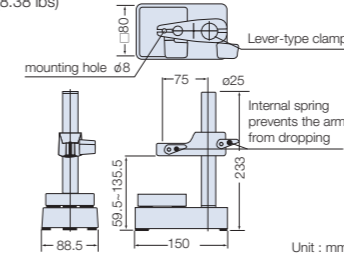

DZ173 Air release (for DE12BR/30BR, U Series)

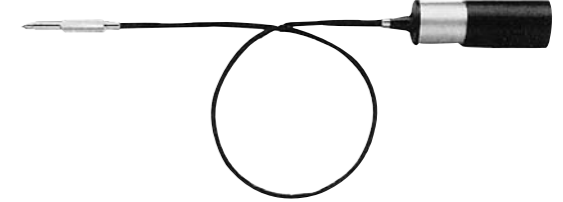

DZ-5100 Feeler set



- Plastic ball contact point: ø 3mm nylon ball

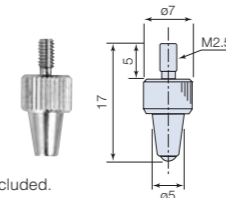

- Flat carbide contact point

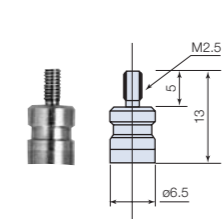

- Off-center contact point: ø 1mm steel ball

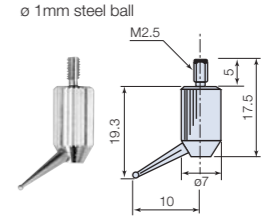

- Pin contact point

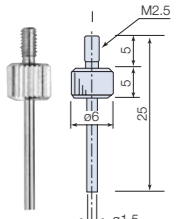

Unit : mm

Note: The four contactors shown at right are included.

Other accessories

- Cable connectors for computer connection (for U Series/ LT Series/ LY Series) DZ252 (round 8 pin ↔ D sub 9 pin) (2 m) DZ253A (round 8 pin ↔ D sub 25 pin) (2 m) DZ254 (round 8 pin ↔ unterminated end)
- Extension cable (for DZ252N/P, DZ253N/P, DZ254N/P) : CE08-1(1m), CE08-3(3m), CE08-5(5m), CE08-10(10m), CE08-15(15m)

*Please refer to p54 for the details of the screw.

Interface unit

MG40 Series	40
MG10/20/30 Series	42

- Up to 100 connectable gauges
- High speed data communication 100Mbit/sec
- Compatible with Ethernet, cc-Link
- Operating voltage : 12-24VDC
- DIN rail mounting (35mm)



Interface unit

System structure

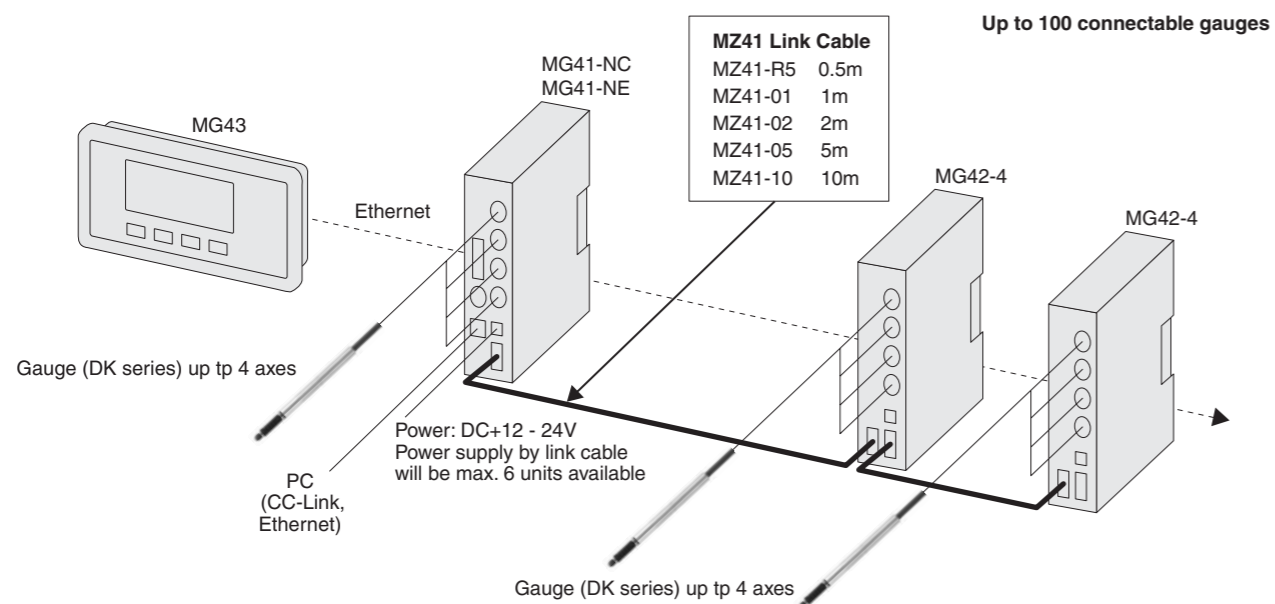

MG series System structures

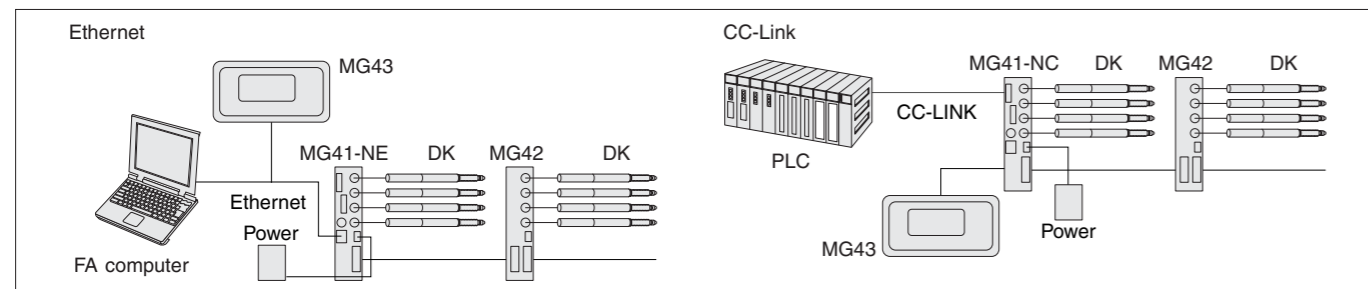

Spec.	Model	DK802A/B	DK805A/B	DK812A/B	DK10	DK25	DK50	DK100	DK110	DK155	DK205	
Min.resolution		0.1μm			0.5μm			0.5μm				
Accuracy		1μm			2μm			4μm				
Measuring Range		2mm	5mm	12mm	10mm	25mm	50mm	100mm	110mm	155mm	205mm	

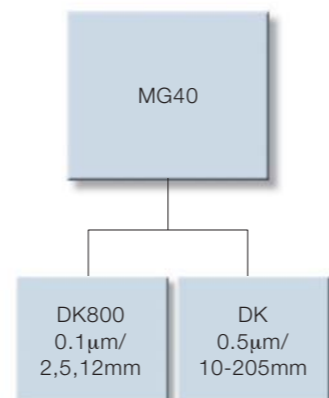
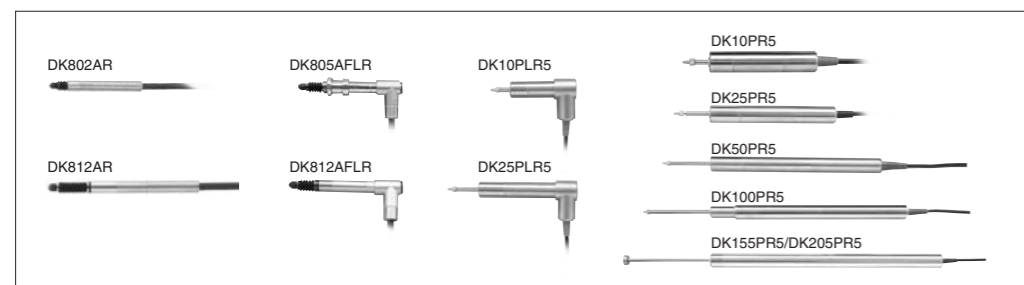

MG40

Specifications		Description		Remarks	
Item	Conditions				
No. of connectable measuring units	Entire system	1 to 100 units (Connection disabled after connection of 101st unit.)		Up to 24 connected MG42 hub units	
	MG41 main unit	0 to 4 axis			
	MG42 hub unit				
Connectable measuring units		DK800A/DK 800B series, DK10, DK25, DK50, DK100, DK110, DK155, DK205			
Connection cable length		Between MG41 main unit and MG42 hub unit, between MG42 hub unit and MG42 hub unit: 0.5 m, 1 m, 2 m, 5 m, 10 m			
		Total cable length from MG41 main unit: Maximum 30 m (Maximum current: 4 A or less)			
Resolution		Settable output data resolution and display resolution			
	Measuring unit resolution (input resolution)	0.1μm 0.5μm	0.1μm 0.5μm 1μm 5μm 10μm		
Measuring unit data import capacity	10 Mbps data transfer	Maximum 10,000 data/s (when 100 axes are connected)		The data for one axis is counted as one data.	
Peak-hold function		Calculation of maximum value, minimum value, and peak-to-peak value for each axis (including pause, latch, and start functions)			
		Peak value is not updated during pause.			
		Output and display data are not updated during latching (internal data is updated)			
Output data	Single axis	Current value, maximum value, minimum value, and peak-to-peak value for each axis		Single axis calculation of an addition/subtraction axis is not possible (or preventing inconsistencies in calculation).	
	Addition and subtraction	Current value, maximum value, minimum value, and peak-to-peak value for the two-axis addition/subtraction axis			
Comparator function		Data for each axis (single axis, addition/subtraction axis) is compared and measured, and the comparator results are output. (Comparator during latch is also latched.)			
	Comparator setting values	2 values	4 values		8 values
	No. of setting value groups	16 groups	8 groups	4 groups	2 groups
Ethernet		100Base-T (compliant with IEEE 802.3) 100 Mbps/10 Mbps (Auto-negotiation) Command input, data output, and parameter setting are possible.			
Reset function		Current value for each axis is reset (by command).			
Preset function		Value is preset to the current value of each axis (by command).			
Datum point setting function		Datum point of each axis can be set (by command).			
Reference point function		Reference point can be used to relocate the datum point of each axis (by command).		When master calibration function is not used	
Master calibration function		Reference point can be used to perform master calibration for each axis (by command).		Addition/subtraction axis cannot be used.	
Measuring unit product information		The product information of the connected measuring unit can be acquired.			
Command/setting enabled or disabled for each communication line	Command	Reset function	Ethernet	Available	When master calibration function is not used
		Preset function			
		Datum point setting function			
Data output	Reference point function				
	Master calibration function				
	Comparator value setting				
Settings	Comparator group number setting				
	Start				
	Pause				
Supply voltage	Terminal input	Latch			
		Current value/Peak value (All axes)	Available	N/A	
		Current value/Peak value (each unit)			
Power consumption	Note the connection conditions.	Comparator result			
		Alarm (Communication/Measuring unit)			
		Soft ware version			
Operating temperature and humidity range	0 to +50 °C (no condensation)	Measuring unit product information			
		Input resolution			
		Display and output resolution			
Storage temperature and humidity range	-10 to +60 °C (20 to 90 % RH)	Axis addition			
		Mass			
		DC 12 to 24 V (11 to 26.4 V)			
Mass	MG41 : 300 g , MG42 : 250 g	Comparator mode (2, 4, 8, or 16 values in 1 group)			
		System total: Max. current 4 A			
		When the maximum current is exceeded, the connection can be enabled by providing a power supply to the MG42 hub units that come later in the connection.			
Operating temperature and humidity range	0 to +50 °C (no condensation)	Power consumption			
		<Details of power consumption for each unit> MG41 main unit : 4 W , MG42 hub unit : 1 W/unit , Measuring unit supply : 1 W/unit			
		Operating temperature and humidity range			
Storage temperature and humidity range	-10 to +60 °C (20 to 90 % RH)	Screen display			
		480 x 272 pixels, 4.3-inch TFT LCD with backlight			
		Approx.500g			

Display unit MG43

Specifications		Description	
Item	Description	Item	Description
Compatible main units	MG41-NE/MG41-NC	Network interface	100Base-TX / 10Base-T (compliant with IEEE802.3) Auto-negotiation
Compatible hub units	Hub units compatible with the main unit	Power consumption	DC12~24V(11~26.4V)
Compatible measuring units	Measuring units compatible with the main unit or hub unit	Power supply	4W
Main functions	Measure Monitor, Setting Monitor, System Monitor	Operating temperature range	0 to +40°C (no condensation)
Communication protocol	MG40 original protocol on TCP/IP	Storage temperature and humidity range	-10~+60°C (20~90%RH)
Screen display	480 x 272 pixels, 4.3-inch TFT LCD with backlight	Mass	Approx.500g

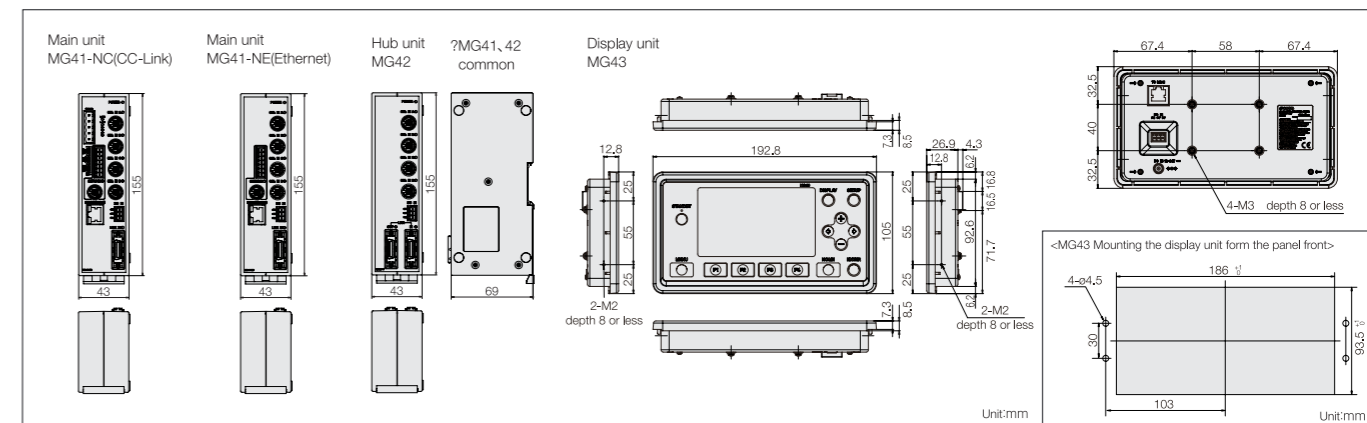

MG

MG10/20/30 SERIES

Flexible digital gauge system for multi-point measuring .

- Up to 64 connectable gauges
- Input resolutions : 0.1μm, 0.5μm, 1μm, 5μm, and 10μm.
- Compatible with RS-232C, BCD
- Operating voltage : 12-24VDC
- DIN rail mounting (35mm)



Interface unit

System structure

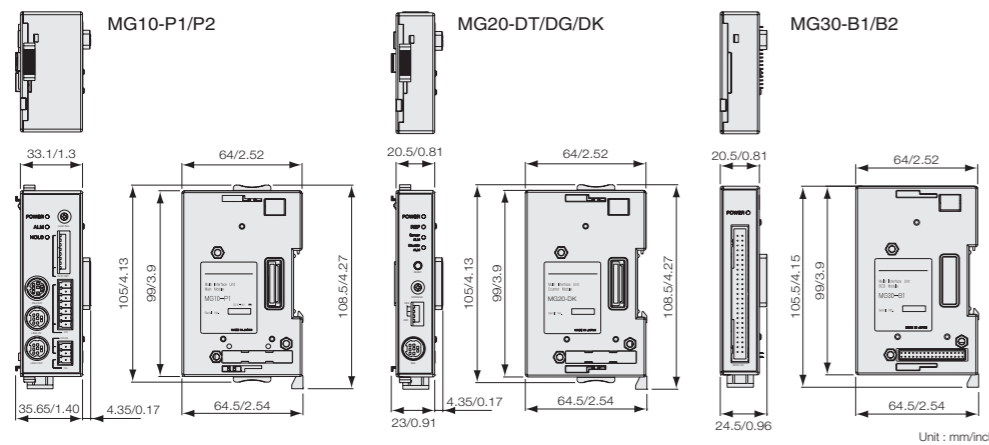

"MG" Multi Interface unit operates with a variety of modules.

- Counter module (MG20)
 - Digital gauge input
 - Resolution setting
- I/F module (MG30)
 - BCD / GO / NO GO output
 - Expansion module (Sequential lineup)
 - Connection with Counter module, I/F module

Main module (MG10)

- Power supply
- RS-232C Connection
- Connection with Counter module, I/F module

MG10-P1 : sink type output (-com)
 MG10-P2 : source type output (+com)

MG20-DK : DK series gauges
 MG20-DG : DG**B and DL**B/BR series gauges
 MG20-DT : DT series gauges

MG30-B1 : BCD sink type output (-com)
 MG30-B2 : BCD source type output (+com)

MG series System structures

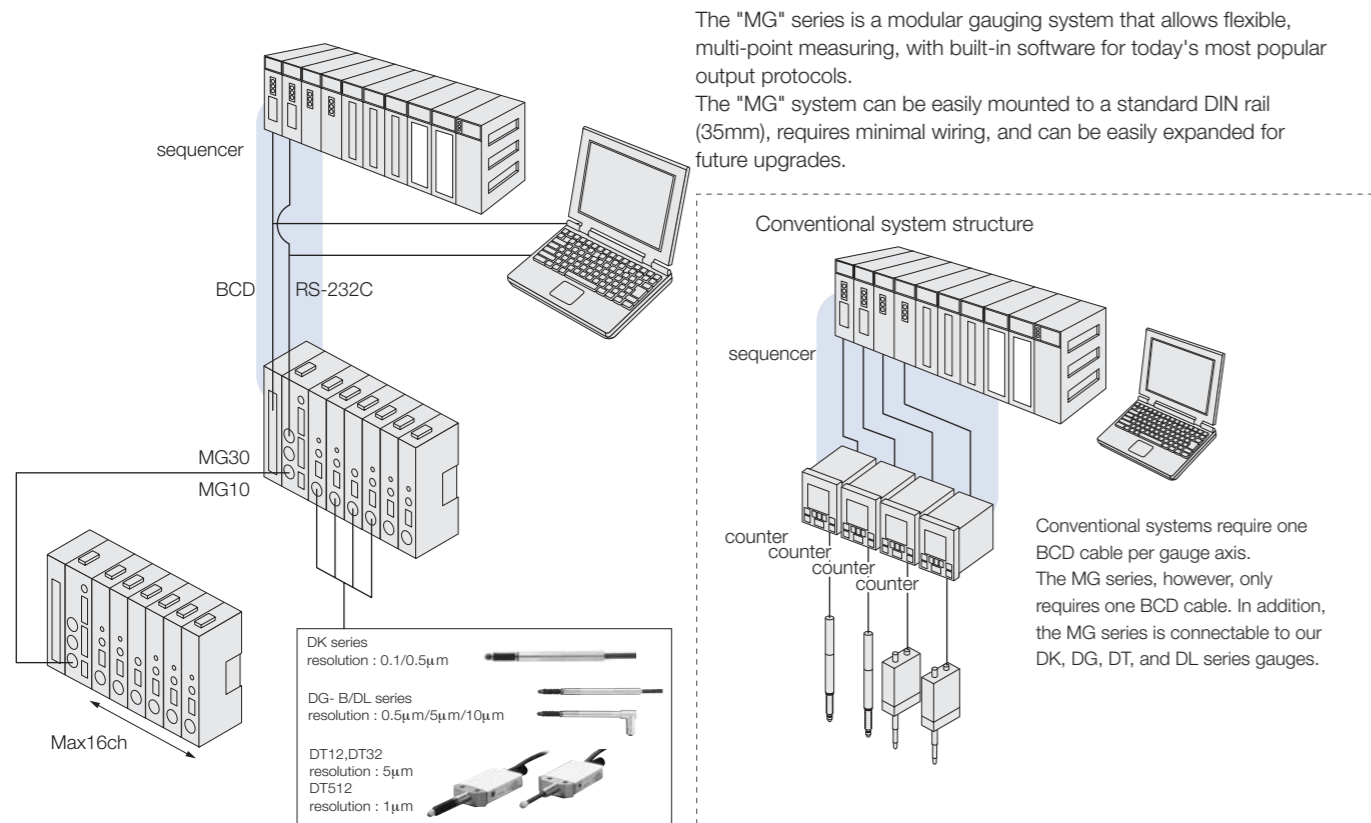

Main module

Model name	MG10-P1	MG10-P2
Power source	Supply voltage	DC12-24V(11-26.4V)Min. startup time: 100ms or less
	Power consumption	2.0W + total power consumption for connected modules ^{*1}
	Inrush current (10ms)	10A or less (when maximum number of modules are connected)
	Power supply protection	Fuse (5A fuse is built in.)
Communication	Communication I/F	RS-232C (EIA-232C or equivalent)
	Baud rate setting	2400 / 9600 / 19200 / 38400 bps (set with DIP switch)
	Data length	7 / 8 bit (set with DIP switch)
	Stop bit	1 / 2 bit (set with DIP switch)
	Parity	none / ODD / EVEN (set with DIP switch)
Linkage function	Delimiter	CR / CR+LF (set with DIP switch)
	Maximum number of linkages	16 (total of counter modules: 64)
I / O	Maximum length of linking cable	10m
	Input format	source input (+COM) / sink input (-COM)
	Output format	Photo coupler insulation, external power: DC5 - 24V / sink type (-COM) / source type (+COM)
	Input signal	Photo coupler insulation, external power: DC5 - 24V / reset, pause, start, latching, and data out trigger to whole channels
Connectable modules	Output signal	integrated alarm
	Counter modules	MG20-DK, MG20-DG and MG-20DT (available for mixed use, up to 16 modules) ^{*1}
	Interface modules	MG30-B1, MG30-B2

*1: Total power of modules connected to MG10 should not be over 54W (12VDC Input) or 108 W (24VDC Input).

Counter module

Model name	MG20-DK	MG20-DG	MG20-DT	
Power consumption	1W + power consumption for connected gauge	1.4W (connected to DG-B) / 0.5W (connected to DL-B)	0.8W	
	Corresponding gauge	DK series (A/B quadrature input)	DG**B series, DL**B/DL**BR series	DT series
Measuring unit input	Allowable resolution setting ^{*2}	10 / 5 / 1 / 0.5 / 0.1μm	10 / 5 / 0.5μm	5μm (DT12/32) 1μm (DT512)
	Maximum response speed	Subject to the specification of the connected gauge		
	Reference point ^{*3}	REF-LED (reference point loaded) shows on the display after the reference point is detected. Set "0" or preset value on the counter when the reference point is detected.		
Others	Alarm	S-ALM LED activates by excess speed/acceleration of measuring unit. C-ALM LED activates by excess speed of the internal circuit of counter.		
		Alarm display is cancelled by reset command from MG10 or with the reset button of main unit.		

*2: Set the resolution value of the connected gauge. *3: MG20-DG work only connect to DL**BR series

Interface module

Model name	MG30-B1	MG30-B2
Power consumption	source input (+com)	1w
	sink input (-com)	
I/O	Input format	Photo coupler insulation, external power: DC5 - 24V
	Output format	Photo coupler insulation, external power: DC5 - 24V / sink type (-com) / source type (+com)
	Input signal	Photo coupler insulation, external power: DC5 - 24V
Output setting	Output signal	DRQ / channel address / measuring mode shifting / comparator shifting / reset / start / posing / reference point loaded
		BCD data (6 digits) / READY / code / GO/NO GO output / alarm / reference point loaded
All models	timer (1-128ms) / OUT / OR / polarity (set with internal DIP switch)	
	Operating temperature	0-+50°C (No condensation)
	Storage temperature	-10-+60°C (20-90%RH)

Counter unit

LT30 SERIES	46
LT20A SERIES	47
LT11A SERIES	48
LT10A SERIES	49
LY71	50
LY72	51

LT

LT30 SERIES (for DK series)

Counter compatible with our compact, high-precision DK series of digital gauges.



Counter unit

- Maxmum display resolution : 0.1μm
- Zero point detection
- BCD and RS-232C I/O models are available.
- Compact and lightweight: DIN standardsize (W 72mm x H 72mm)
- Comparator ● Reset/Preset
- Alarm for exceeded max. response speed and disconnected measuring unit
- Setting value storage
- 2-axis ADD/SUB (2-axis model only)

System structure

System Configuration

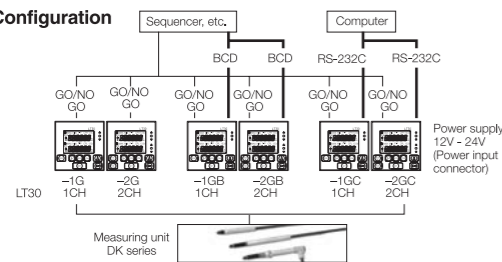

Dimensions(LT30-2GB)

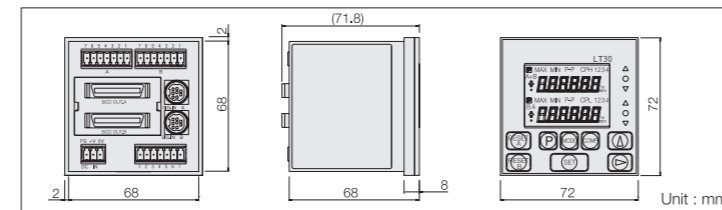

Part Names

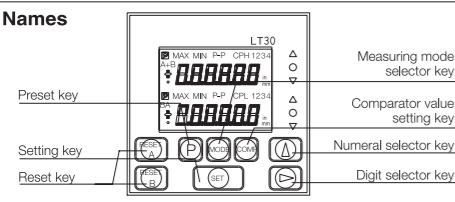

Input/output Pins

- I/O connector
Inputs : Reset, Peak hold start, Peak hold pause
Outputs : GO/NO GO ● Power input connector : 12 to 24V DC power
- BCD (36-pin half-pitch connector)
Inputs : Comparator value selection (4 settings), Mode selection (Current value, Maximum measured value, Minimum measured value, P-P value) Outputs (Open collector) : Measured data (6 digits), Alarm output
- RS-232C (8-pin mini-DIN connector) Reset, Preset value setting/recall, Peak hold start, Peak hold pause, Comparator value setting, Mode selection and output (Current value, Maximum measured value, Minimum measured value, P-P value)
- RS-TRG Trigger inputs for RS-232C data outputs

Separate accessories (Connectable to LT30-1GC/2GC)

- RS-232C cable DZ252 : D-sub 9-pin DZ253A : D-sub 25-pin

Common Specifications

Model	LT30-1G	1GB	1GC	2G	2GB	2GC
Display	6 digit backlit LCD, mode display					
I/O	Measuring unit input	1 channel			2 channel	
	I/O connectors *1	○			○	
	BCD *2	○			○	
	RS-232C *3	○			○	
RS-TRG *4	○			○		
Reset function	Reset key or external input (I/O connectors)					
Preset function	Preset value set with preset key, recalled with reset key.					
Comparator function	Three-level comparator Comparator value set with keys on the front panel. Result evaluation: LED and I/O connector output (photocoupler)					
	—	Up to 4 values can be set for comparator (key input). Switched with BCD terminal.	Set with RS-232C command	—	Up to 4 values can be set for comparator (key input). Switched with BCD terminal.	Set with RS-232C command
Peak hold function	Maximum, minimum, and peak-to-peak values. Measuring started by the start input of the I/O connector; update stop by pause input.					
Input resolution	0.0001 mm, 0.0005 mm, 0.001 mm, 0.005 mm, 0.01 mm selectable					
Display resolution	0.0001 mm, 0.0005 mm, 0.001 mm, 0.005 mm, 0.01 mm (0.00002", 0.00005", 0.0002", 0.0005") selectable					
Direction	Can be switched					
Reference point function	Function use enabled/disabled can be selected (if use is enabled, the unit enters reference point signal input wait status at the same time as power-on).					
Maximum response speed	20 MHz (A/B phase difference)					
Addition and subtraction function	A+B, A-B, B-A can be set with the direction setting.					
Alarm	Speed over or measuring unit cable disconnected (Displayed on LCD or the I/O connector's comparator outputs are all "H" (OFF)).					
Data storage	Resolution, direction, comparator value, preset value, modes, etc.					
	—	BCD sign, etc	Data signalling rate, etc.	—	BCD sign, etc	Data signalling rate, etc.
Temperature	Operating temperature: 0 to 40°C Storage temperature: -10 to 50°C					
Power consumption *5	5 W	5.5 W	5 W	8.5 W	9 W	8.5 W
Mass	Approx. 200 g	Approx. 230 g	Approx. 220 g	Approx. 210 g	Approx. 270 g	Approx. 230 g
Power voltage	Power input connector (3 pins) : DC9.0 to 26.4 V.					
Compatible measuring unit	DK series					

Note 1 : I/O connector
Input : Reset, peak-hold start, peak-hold pause, RS trigger (RS-232C models only)
Output : Result evaluation (photocoupler)
Note 2 : BCD (36 pin half-pitch connector)
Input : Reset, peak-hold start, comparator value selection (4 settings)
Output : five digits (open collector) One of current value/maximum value/minimum value/peak-to-peak value selected and output.
Note 3 : RS-232C (8 pin mini-DIN connector)
Reset, preset value setting/recall, peak-hold start, peak-hold pause, current value hold, software version read, comparator value setting, current value/maximum value/minimum value/peak-to-peak measuring mode selection and output, key lock and release.

Note 2 : BCD (36 pin half-pitch connector)
Input : Reset, peak-hold start, comparator value selection (4 settings)
Output : five digits (open collector) One of current value/maximum value/minimum value/peak-to-peak value selected and output.
Alarm output
Note 4 : RS-TRG pin
Trigger input for RS-232C data output
Note 5 : With measuring unit connected.

LT

LT20A SERIES (for DG, DL)

Compact, lightweight, and easy-to-mount counter



Counter unit

- Compact design : DIN standard size (72 mm x 72 mm / 2.83" x 2.83" W x H).
- Suitable for panel mounting ● Selectable display resolutions: 0.5/ 1/ 5/ 10 μm
- BCD and RS-232C I/O models are available.
- Reset/preset ● Peak hold function for measuring max./ min./ peak-to-peak values and GO/NO GO evaluation. ● ADD/ SUB function (2-axis model only)
- Data storage : resolution, counting direction, comparator reference points, preset value, mode, BCD sign (B type), communication parameters (C type)
- Inch/ metric display
- Applications: automatic sorting and measuring of parts on production lines.

Dimensions

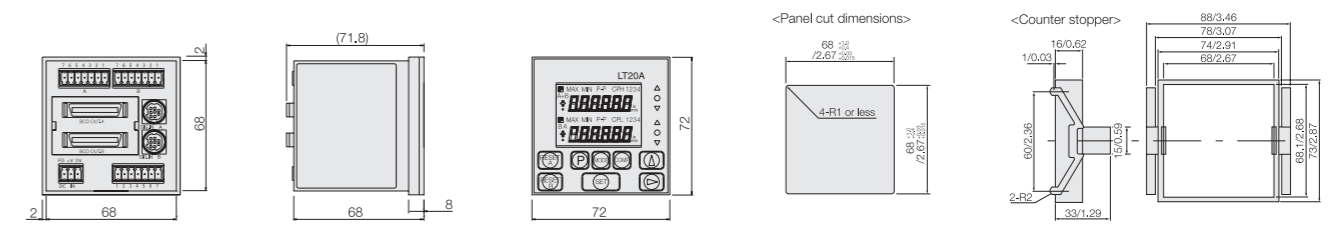

Unit : mm/inch

Common Specifications

Model	LT20A-101	101B	101C	201	201B	201C
Display	6 digit backlit LCD, mode display					
I/O	Measuring unit input	1 channel			2 channel	
	I/O connectors *1	○			○	
	BCD *2	○			○	
	RS-232C *3	○			○	
RS-TRG *4	○			○		
Reset function	Reset key or external input (I/O connectors)					
Preset function	Preset value set with preset key, recalled with reset key.					
Comparator function	Three-level comparator Comparator value set with keys on the front panel. Result evaluation: LED and I/O connector output (photocoupler)					
	—	Up to 4 values can be set for comparator (key input). Switched with BCD terminal.	Set with RS-232C command	—	Up to 4 values can be set for comparator (key input). Switched with BCD terminal.	Set with RS-232C command
Peak hold function	Maximum, minimum, and peak-to-peak values. Measuring started by the start input of the I/O connector; update stop by pause input.					
Input resolution	0.0005 mm, 0.001 mm, 0.005 mm, 0.01 mm selectable					
Display resolution	0.0005 mm, 0.001 mm, 0.005 mm, 0.01 mm (0.00002", 0.00005", 0.0002", 0.0005") selectable					
Direction	Can be switched					
Reference point function	Function use enabled/disabled can be selected (if use is enabled, the unit enters reference point signal input wait status at the same time as power-on).					
Maximum response speed	20 MHz (A/B phase difference)					
Addition and subtraction function	A+B, A-B, B-A can be set with the direction setting.					
Alarm	Speed over or measuring unit cable disconnected (Displayed on LCD or the I/O connector's comparator outputs are all "H" (OFF)).					
Data storage	Resolution, direction, comparator value, preset value, modes, etc.					
	—	BCD sign	Data signalling rate, etc.	—	BCD sign	Data signalling rate, etc.
Temperature	Operating temperature: 0 to 40°C Storage temperature: -10 to 50°C					
Power consumption *5	4 W	5 W	4 W	6 W	8 W	6 W
Mass	Approx. 200 g	Approx. 230 g	Approx. 220 g	Approx. 210 g	Approx. 270 g	Approx. 230 g
Power voltage	Power input connector (3 pins) : DC9.0 to 26.4 V.					
Compatible measuring unit	DG, DL series					

Note 1 : I/O connector
Input : Reset, peak-hold start, peak-hold pause, RS trigger (RS-232C models only)
Output : Result evaluation (photocoupler)
Note 2 : BCD (36 pin half-pitch connector)
Input : Reset, peak-hold start, comparator value selection (4 settings)
Output : five digits (open collector) One of current value/maximum value/minimum value/peak-to-peak value selected and output.
Note 3 : RS-232C (8 pin mini-DIN connector)
Reset, preset value setting/recall, peak-hold start, peak-hold pause, current value hold, software version read, comparator value setting, current value/maximum value/minimum value/peak-to-peak measuring mode selection and output, key lock and release.

Note 2 : BCD (36 pin half-pitch connector)
Input : Reset, peak-hold start, comparator value selection (4 settings)
Output : five digits (open collector) One of current value/maximum value/minimum value/peak-to-peak value selected and output.
Alarm output
Note 4 : RS-TRG pin
Trigger input for RS-232C data output
Note 5 : With measuring unit connected.

LT

LT11A SERIES (for DT512)

Compact, lightweight,
and easy-to-mount counter.



Counter unit

- Compact size : DIN standard (72 mm x 72mm / 2.83" x 2.83" W x H)
- Resolution: 1, 5, 10 μ m Selectable
- Suitable for panel mounting
- Direct interfacing from display unit to PLC or computer
- Current values, maximum, minimum, peak-to-peak values and GO/NO GO evaluation included as standard functions.
- ADD/SUB function (2-channel model)
- Full lineup for various applications

Dimensions

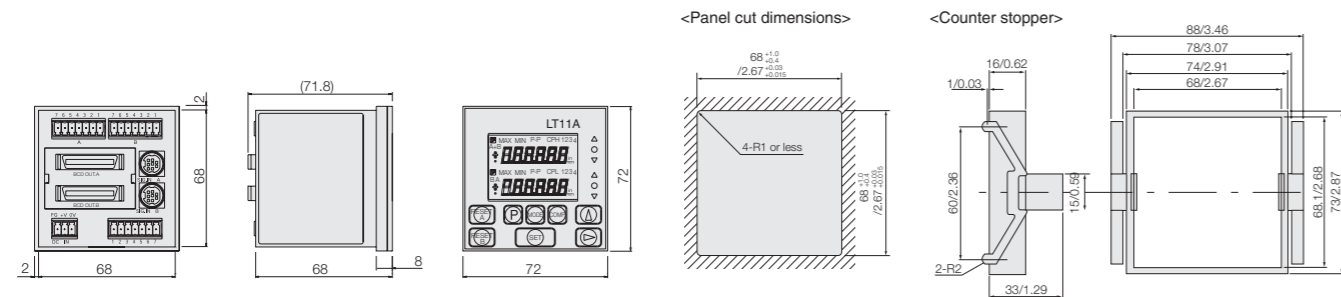

Unit : mm/inch

Common Specifications							
Model	LT11A-101	101B	101C	201	201B	201C	
Display	5 digit backlit LCD, mode display						
I/O	Measuring unit input	1 channel			2 channel		
	I/O connectors *1	○					
	BCD *2	—	○	—	—	○	
	RS-232C *3	—	—	○	—	○	
	RS-TRG *4	—	—	○	—	○	
Reset function	Reset key or external input (I/O connectors)						
	—	BCD terminal	RS-232C command	—	BCD terminal	RS-232C command	
Preset function	Preset value set with preset key, recalled with reset key.						
	—	Recalled with BCD reset terminal	Set or recalled with RS-232C command	—	Recalled with BCD reset terminal	Set or recalled with RS-232C command	
Comparator function	Three-level comparator Comparator value set with keys on the front panel. Result evaluation: LED and I/O connector output (photocoupler)						
	—	Up to 4 values can be set for comparator (key input). Switched with BCD terminal.	Set with RS-232C command	—	Up to 4 values can be set for comparator (key input). Switched with BCD terminal.	Set with RS-232C command	
Peak hold function	Maximum, minimum, and peak-to-peak values. Measuring started by the start input of the I/O connector; update stop by pause input.						
	—	Can be started with the BCD terminal.	RS-232C can set or start.	—	Can be started with the BCD terminal.	RS-232C can set or start.	
Resolution	0.001 mm, 0.005 mm, 0.01 mm selectable						
Direction	Can be switched						
Maximum response speed	100 m/min			80 m/min			
Addition and subtraction function	A+B, A-B, B-A can be set with the direction setting.						
Alarm	Displayed on LCD or the I/O connector's comparator outputs are all "H" (OFF).						
	—	BCD alarm terminal "H" (OFF)	—	—	BCD alarm terminal "H" (OFF)	—	
Data storage	Resolution, direction, comparator value, preset value, modes, etc.						
	—	BCD sign	Data signalling rate, etc.	—	BCD sign	Data signalling rate, etc.	
Temperature	Operating temperature: 0 to 40°C Storage temperature: -10 to 50°C						
Power consumption *5	1.8 W	2.9 W	2.0 W	2.3 W	4.0 W	2.5 W	
Mass	Approx. 200 g	Approx. 230 g	Approx. 220 g	Approx. 210 g	Approx. 270 g	Approx. 230 g	
Power voltage	Power input connector (3 pins) : DC9.0 to 26.4 V.						
Compatible measuring unit	DT512 series						

Note 1 : I/O connector

Input : Reset, peak-hold start, peak-hold pause, RS trigger (RS-232C models only)
Output : Result evaluation (photocoupler)

Note 3 : RS-232C (8 pin mini-DIN connector)

Reset, preset value setting/recall, peak-hold start, peak-hold pause, current value hold, software version read, comparator value setting, current value/maximum value/minimum value/peak-to-peak measuring mode selection and output, key lock and release.

Note 2 : BCD (36 pin half-pitch connector)

Input : Reset, peak-hold start, comparator value selection (4 settings)
Output : five digits (open collector) One of current value/maximum value/minimum value/peak-to-peak value selected and output.

Alarm output

Note 4 : RS-TRG pin

Trigger input for RS-232C data output

Note 5 : With measuring unit connected.

LT

LT10A SERIES (for DT12/32)

Compact, lightweight,
and easy-to-mount counter.



Counter unit

- Compact size : DIN standard (72 mm x 72 mm / 2.83" x 2.83" W x H)
- Resolution : 5, 10 μ m Selectable
- Suitable for panel mounting
- Direct interfacing from display unit to PLC or computer
- Current values, maximum, minimum, peak-to-peak values and GO/NO GO evaluation included as standard functions.
- ADD/SUB function (2-channel model)
- Full lineup for various applications

Dimensions

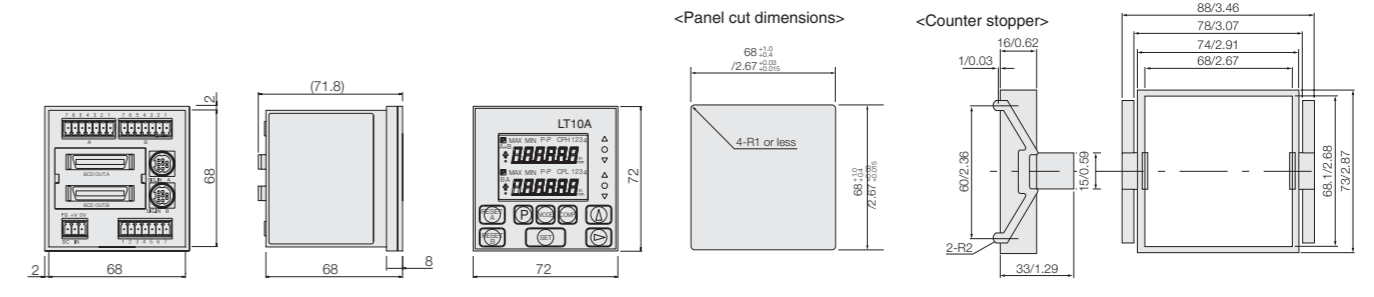

Unit : mm/inch

Common Specifications							
Model	LT10A-105	105B	105C	205	205B	205C	
Display	5 digit backlit LCD, mode display						
I/O	Measuring unit input	1 channel			2 channel		
	I/O connectors *1	○					
	BCD *2	—	○	—	—	○	
	RS-232C *3	—	—	○	—	○	
	RS-TRG *4	—	—	—	—	○	
Reset function	Reset key or external input (I/O connectors)						
	—	BCD terminal	RS-232C command	—	BCD terminal	RS-232C command	
Preset function	Preset value set with preset key, recalled with reset key.						
	—	Recalled with BCD reset terminal	Set or recalled with RS-232C command	—	Recalled with BCD reset terminal	Set or recalled with RS-232C command	
Comparator function	Three-level comparator Comparator value set with keys on the front panel. Result evaluation: LED and I/O connector output (photocoupler)						
	—	Up to 4 values can be set for comparator (key input). Switched with BCD terminal.	Set with RS-232C command	—	Up to 4 values can be set for comparator (key input). Switched with BCD terminal.	Set with RS-232C command	
Peak hold function	Maximum, minimum, and peak-to-peak values. Measuring started by the start input of the I/O connector; update stop by pause input.						
	—	Can be started with the BCD terminal.	RS-232C can set or start.	—	Can be started with the BCD terminal.	RS-232C can set or start.	
Resolution	0.005 mm, 0.01 mm selectable						
Direction	Can be switched						
Maximum response speed	100 m/min			80 m/min			
Addition and subtraction function	A+B, A-B, B-A can be set with the direction setting.						
Alarm	Displayed on LCD or the I/O connector's comparator outputs are all "H" (OFF).						
	—	BCD alarm terminal "H" (OFF)	—	—	BCD alarm terminal "H" (OFF)	—	
Data storage	Resolution, direction, comparator value, preset value, modes, etc.						
	—	BCD sign	Data signalling rate, etc.	—	BCD sign	Data signalling rate, etc.	
Temperature	Operating temperature: 0 to 40°C Storage temperature: -10 to 50°C						
Power consumption *5	1.8 W	2.9 W	2.0 W	2.3 W	4.0 W	2.5 W	
Mass	Approx. 200 g	Approx. 230 g	Approx. 220 g	Approx. 210 g	Approx. 270 g	Approx. 230 g	
Power voltage	Power input connector (3 pins) : DC9.0 to 26.4 V.						
Compatible measuring unit	DT12/32 series						

Note 1 : I/O connector

Input : Reset, peak-hold start, peak-hold pause, RS trigger (RS-232C models only)
Output : Result evaluation (photocoupler)

Note 3 : RS-232C (8 pin mini-DIN connector)

Reset, preset value setting/recall, peak-hold start, peak-hold pause, current value hold, software version read, comparator value setting, current value/maximum value/minimum value/peak-to-peak measuring mode selection and output, key lock and release.

Note 2 : BCD (36 pin half-pitch connector)

Input : Reset, peak-hold start, comparator value selection (4 settings)
Output : five digits (open collector) One of current value/maximum value/minimum value/peak-to-peak value selected and output.

Alarm output

Note 4 : RS-TRG pin

Trigger input for RS-232C data output

Note 5 : With measuring unit connected.

LY

LY71

For measurements and control in diverse field uses.
The required output board can be extended.

- Various outputs are enabled by mounting extension boards
 - BCD Output (Option)
 - Comparator Function: Relay / Open-collector (Option)
- Peak Hold Function Convenient for Statistical Measurement
- Convenient External Input Functions for Automatic Measurement
- Display Resolution Switching ● Data Storage.
- Reset/Preset/Restart ● Detecting Reference Point of Measurement Unit
- Scaling ● Flicker Control



Counter unit

Dimensions

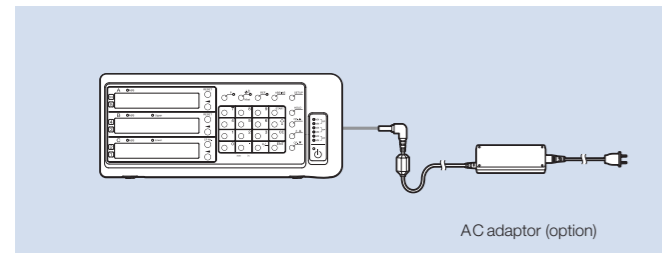
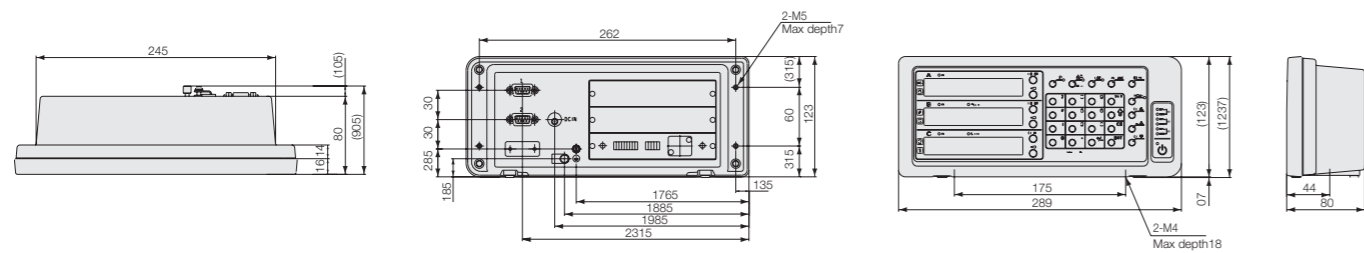

AC adaptor (option)

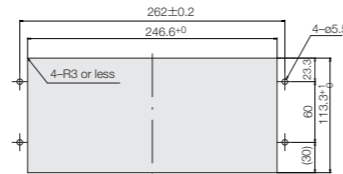

Mounting the counter unit from the panel front.

Unit : mm/inch

*Please refer to p54 for the details of the screw.

Specifications

Model	LY71
Display	7 digits and minus display, Color amber
Number of input shafts	1 or 2 axes (2-axis add function available; addition only is displayed when adding)
Display data	Current (1st axis, 2nd axis, addition axis), maximum, minimum and peak-to-peak values
Measuring unit input resolution	Standard : 0.1 μm, 0.5 μm, 1 μm, 5 μm, 10 μm, 1 s, 10 s, 1 min, 10 min Expanded : 100 μm, 50 μm, 25 μm, 20 μm, 2 μm, 0.05 μm, and 1 degree can be added.
Input signal	A/B quadrature signal, Z signal (Conforms to EIA-422)
Display resolution	Measuring unit input resolution or higher and supported inch units Inch: Basic : 0.000005", 0.00001", 0.00005", 0.0002", 0.0005" Inch: Expanded: 0.000002", 0.0001", 0.001", 0.002", 0.005"
Minimum input phase difference	100 ns
Alarm display	Measuring unit disconnected, Excess speed, Maximum display amount exceeded, Power failure, Error in stored data
Reset	Current value reset, Alarm cancel
Restart	Restart of peak value calculation for each axis/all axes
Preset	It is possible to store/edit up to three values for each axis.
Master calibration function	The master calibration value is relocated when going past the reference point after the power is turned on.
Datum point operations	It is possible to store/edit one value for each axis (when not using the master calibration function).
Reference point operations	It is possible to store/edit one value for each axis (when not using the master calibration function).
Hold function	Selectable from latch and pause Latch : Display held while latched (Display hold) Pause : Peak calculation stopped while paused (Peak calculation hold)
Linear compensation	A fixed compensation amount is applied to the measuring unit's count value. Compensation amount Standard: ±600 μm/m (Expanded: ±1000 μm/m)
Scaling	Scaling factor: 0.100000 to 9.999999
Power supply	DC 12 V Rating 0.75 A Max. 1 A AC 100 V to 240 V ±10 % When using the AC adaptor PSC-22 (For U.S. only) or PSC-23 (For Europe and other countries) *Option
Power consumption	MAX. 32 VA connected at the AC adaptor.
Operating temperature	0 to 40 °C (no condensation)
Storage temperature	-20 to 60 °C (no condensation)
Mass	Approx. 1.5 kg

LY

LY72

For measurements and control in diverse field uses.
Multifunction counter with RS-232C interface

- RS-232C standard function
- Peak Hold Function Convenient for Statistical Measurement
- Convenient External Input Functions for Automatic Measurement
- Display Resolution Switching
- Data Storage.
- Reset/Preset/Restart
- Detecting Reference Point of Measurement Unit
- Scaling ● Flicker Control



Counter unit

Dimensions

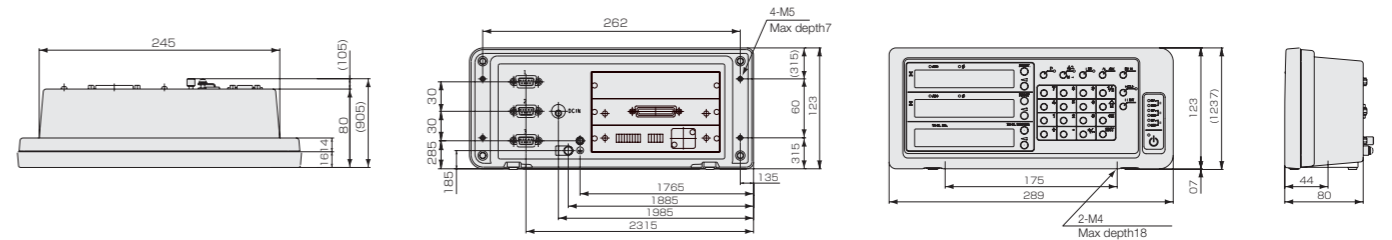

Unit : mm/inch

*Please refer to LY71 panel cut-out diagram.

*Please refer to p54 for the details of the screw.

Specifications

Model	LY72	
Specifications by application	Applications as gauge (set axis labels A, B, and C)	Applications as scale (set axis labels X, Y, and Z)
Display	7 digits and minus display, Color amber	
Number of input shafts	1 to 3 axis	
Display data	Current (1st axis, 2nd axis, addition axis), maximum, minimum and peak-to-peak values	Current (1st axis, 3rd axis, addition axis)
Measuring unit input resolution	Standard : 0.1 μm, 0.5 μm, 1 μm, 5 μm, 10 μm, 1 s, 10 s, 1 min, 10 min Expanded : 100 μm, 50 μm, 25 μm, 20 μm, 2 μm, 0.05 μm, and 1 degree can be added.	
Input signal	A/B quadrature signal, Z signal (Conforms to EIA-422)	
Display resolution	Measuring unit input resolution or higher and supported inch units Inch: Basic : 0.000005", 0.00001", 0.00005", 0.0002", 0.0005" Inch: Expanded: 0.000002", 0.0001", 0.001", 0.002", 0.005"	
Minimum input phase difference	100 ns	
Alarm display	Measuring unit disconnected, Excess speed, Maximum display amount exceeded, Power failure, Error in stored data	
Reset	Current value reset, Alarm cancel	
Restart	Restart of peak value calculation for each axis/all axes	
Preset	It is possible to store/edit up to three values for each axis.	
Master calibration function	The master calibration value is relocated when going past the reference point after the power is turned on.	—
Datum point operations	It is possible to store/edit one value for each axis (when not using the master calibration function).	
Reference point operations	It is possible to store/edit one value for each axis (when not using the master calibration function).	
Hold function	Selectable from latch and pause Latch : Display held while latched (Display hold) Pause : Peak calculation stopped while paused (Peak calculation hold)	Display hold
Linear compensation	A fixed compensation amount is applied to the measuring unit's count value. Compensation amount Standard: ±600 μm/m (Expanded: ±1000 μm/m)	
Scaling	Scaling factor: 0.100000 to 9.999999 Data format : All axes on same line/New line for each axis Peak-to-peak value Transfer rate : 38400/19200/9600/4800/2400/1200 bps Parity : None / Odd / Even Stop bit : 1 or 2 Data length : 8 bits or 7 bits	
RS-232C	Timer	OFF/0.2/0.5/1/5/10/30/60/300 seconds
	Output data selection	Current value/Maximum value/Minimum value Peak-to-Peak value
Power supply	DC 12 V Rating 0.75 A Max. 1 A AC 100 V to 240 V ±10 % When using the AC adaptor PSC-22 (For U.S. only) or PSC-23 (For Europe and other countries) *Option	
Power consumption	MAX. 32 VA connected at the AC adaptor.	
Operating temperature	0 to 40 °C (no condensation)	
Storage temperature	-20 to 60 °C (no condensation)	
Mass	Approx. 1.5 kg	

Technical information

LT Series Usage Note

I/O connector

The I/O connector on the rear panel of the counter unit has functions for Go/No Go output based on the comparator function, start input, pause input, RS-232C trigger input and reset input.

<Connector pin assignment (LT30,20A,11A,10A)>

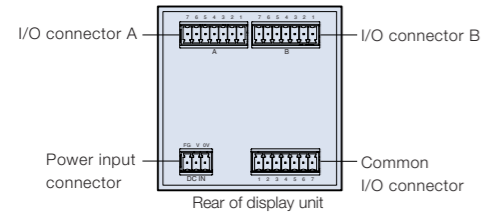

Use a shielded cable for connection to the FG pin on the rear of the display unit. (Prepare a shield cable by yourself.)

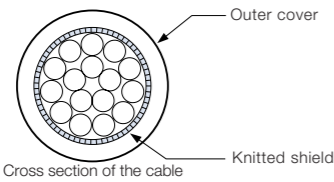

Connector used: MC1.5/7-ST-3.5 (provided) made by Phoenix Contact

Signal
(See "4-3. Function description".)
I/O connector A

Pin No.	Signal name	IN/OUT	Signal
1	GND	-	
2	NC	-	Connection prohibited
3	RESET (A)	IN	Reset input (A CH)AB
4	LO (A)	OUT	Go/No Go output Low (A CH)
5	GO (A)	OUT	Go/No Go output Go (A CH)
6	HI (A)	OUT	Go/No Go output High (A CH)
7	GND	-	

I/O connector B (not provided for 1-channel models)

Pin No.	Signal name	IN/OUT	Signal
1	GND	-	
2	NC	-	Connection prohibited
3	RESET (B)	IN	Reset input (A CH)AB
4	LO (B)	OUT	Go/No Go output Low (B CH)
5	GO (B)	OUT	Go/No Go output Go (B CH)
6	HI (B)	OUT	Go/No Go output High (B CH)
7	GND	-	

Installing the display unit

When mounting in a panel

1. Cut out an opening to match the dimensions shown (Fig.2)
2. Insert the display unit into the cut-out opening in the panel from the front.
3. Attach the supplied installation brackets (upper / lower) from the rear.
4. Use fingers to tighten and secure.

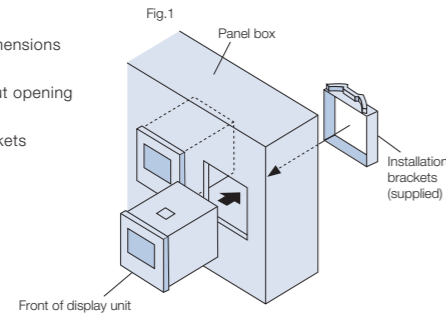

Fig.2 Cut-out dimensions

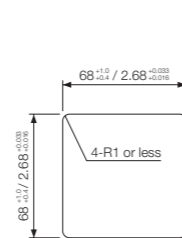
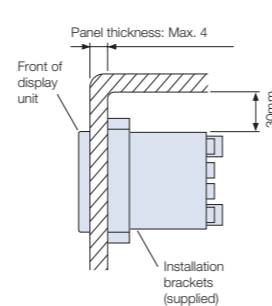

Fig.3



Unit : mm/inch

Note: When attaching the installation brackets to the display unit, leave enough space (min. 30mm) between it and the panel.

Accessories

LZ71 series Expansion boards (for LY71)

The functions of your LY71 counter unit can be expanded simply by inserting the expansion unit into the LY71.

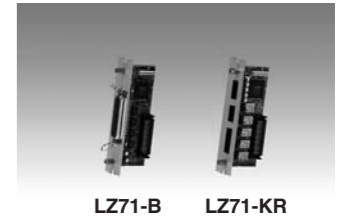

LZ71-B

- BCD output of various data
- Various output modes
- Open collector output

LZ71-KR

- Comparator function for various data
- Switching between 16 sets of data
- Open collector output/relay output

Specifications

Model	LZ71-B
BCD output	7 digit parallel data (4 bits x 7 digits), sign (1 bit), READY signal (1 bit) Output logic positive and negative logic can be selected individually for the data and sign by the settings.
Electrical specifications	Photocoupler output VCE : Recommended DC +12 to 24 V IC : Max. 15 mA/terminal, TOTAL: 300 mA Output connector: 36-pin micro ribbon connector
Latch	Selectable from "BCD only latch" and "BCD & display latch" by the initial settings. Input signal : DRQ1 to 3 (Photocoupler: 12 to 24 V)
Operating temperature	0 to 40°C (32 to 104°F) (No condensation)
Storage temperature	-20 to 60°C (-4 to 140°F) (20 to 90 % RH, no condensation)
Model	LZ71-KR
Comparator function	Sets 1 to 4 comparator values for judging the data size.
Comparable data	Comparable data Current, maximum, minimum and peak-to-peak values. (Based on the settings) (1st axis, 2nd axis and addition axis)
Upper limit and lower limit combinations	Selectable from 16 data sets consisting of 1 to 4 comparator setting values.
Judgment outputs	5-point output signal Photocoupler (voltage resistance: 24 V), I _c = 15 mA 5-point output signal Relay : Panasonic Electric Works, Co., Ltd. ATQ209 24 V DC, 120 V AC, 0.3 A
External input	Photo coupler: supports 12 to 24 V
Positioning function (1 point) modes	Sets the positioning data and turns the output signal on for 0.5 s when the set value and the current value match.
Applicable data	Current value only (1st axis or addition axis)
Operating temperature	0 to 40°C (32 to 104°F) (No condensation)
Storage temperature	-20 to 60°C (-4 to 140°F)

LZ71-B

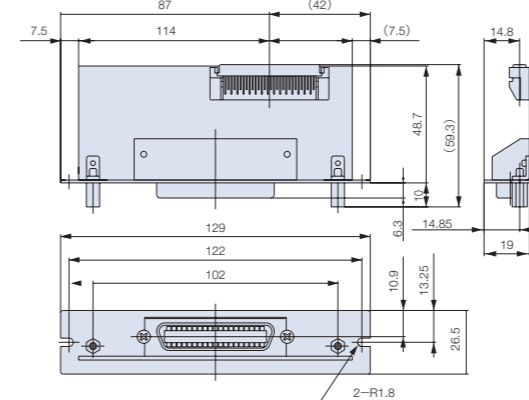

LZ71-KR

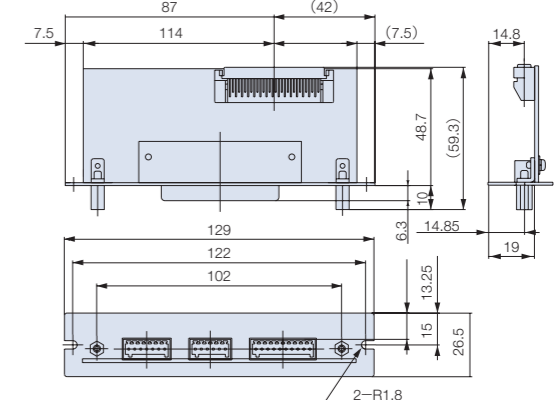

Unit : mm

Other accessories

- Cable connectors for computer connection (for U Series/ LT Series/ LY Series) DZ252 (round 8 pin ↔ D sub 9 pin) (2 m) DZ253A (round 8 pin ↔ D sub 25 pin) (2 m) DZ254 (round 8 pin ↔ unterminated end)

Connection Cables

Measuring unit	Adapter for LT series	LT series	Interface unit	Adapter for Counter	Connection cable	Counter unit	Interpolators	Extension cables
DK805A/B, DK805A/B, DK810A/B	—	LT30	MG (MG10-P1/P2) (MG20-DK) (MG30-B1/B2) (MG41-NC/NE) (MG42-4) Link Cable MZ41-**	—	CE-29-*** ***=-003(0.3m) -01(1m) -05(5m) -10(10m)	LY71, 72	—	CE-08** **=-01(1m), -03(3m), -05(5m), -10(10m), -15(15m)
DK10/25								CE-22** (Open-end) **=-01(1m), -03(3m), -05(5m), -10(10m)
DK50/100								CK-T** (Realize for flexion) CK-T12(1m), T13(3m), T14(5m), T15(10m)
DK155PR5/205PR5								
DK110NLR5								
DT12N/P	—	LT10A	MG (MG10-P1/P2) (MG20-DT) (MG30-B1/B2)	—	MT13 + CE-29	LY71, 72	MT12(for LT20A), MT13(for LT30) MT14(Cable with unterminated)	CE-08** **=-01(1m), -03(3m), -05(5m), -10(10m), -15(15m)
DT32N/NV/P/PV								CK-T12(1m), T13(3m), T14(5m), T15(10m), CK-T10(1m) CK-T105(5m) (Realize for flexion)
DT512N/P								
DG805B/810B	—	LT20A	MG (MG10-P1/P2) (MG20-DG) (MG30-B1/B2)	—	—	LY71, LY72	MD10A/20B ※D-sub15pin Female	—
DG10B/25B								
DG50B/100B/155B/205B								
DG-110B								
DL-B	—	LT20A	MG (MG10-P1/P2) (MG20-DG) (MG30-B1/B2)	DZ51 + SZ70-1	—	LY71, LY72	—	—
DE-BR	SZ70-2	LT30	SZ70-2+ MG (MG10-P1/P2) (MG20-DG) (MG30-B1/B2)	SZ70-1	—	LY71, LY72	—	—

Compatible

Measuring unit	Adapter for LT series	LT series	Adapter for Counter	Connection cable	Counter unit	Interpolators	Extension cables
DT32N/NV/P/PV	Interpolator MT12 LZ60-P1/P2 is required to connect to LT100.	LT20 LT100	—	—	LY51, LY52	—	CE-08** **=-01(1m), -03(3m), -05(5m), -10(10m), -15(15m)
DT512N/P							
DT12N/P							
DT32N/NV/P/PV	—	LT10	MT12 + DZ51	—	LY51, LY52	—	CK-T12(1m), T13(3m), T14(5m), T15(10m) T101(3m) T105(5m) (Realize for flexion)
DT512N/P							
DG805B/810B	—	LT11	DZ51	—	LY51, LY52	—	—
DG10B/25B							
DG50B/100B/155B/205B	—	LT20 LT100					—
DG110B	—	LT20 LT100	DZ51	—	LY51, LY52	—	—
DL-B	—	LT20 LT100	DZ51	—	LY51, LY52	—	—

A description of external form chart of the screw

- When a screw thread is not mentioned in the Dimensions, It is mean numerical value base on standard pitch (National Coarse).
- The screw which conformed to ISO and JIS is enclosed.